



2024

VERSION 1.2

CATALOGO OPERATIVO - OPERATIVE CATALOGUE



C A T A L O G O
O P E R A T I V O

O P E R A T I V E
C A T A L O G U E

2024

VERSION 1.2

Indice alfabetico - Alphabetical index

INTERNI - INDOOR

PAG 133	AURORA
PAG 49	BBTT
PAG 79	BEND MINI INCASSO
PAG 95	BEND SLIM
PAG 93	BEND XS 2019
PAG 93	BEND 2023
PAG 79	BEND XS ESTRAIBILE
PAG 99	BIG BINARIO
PAG 59	BIG INCASSO
PAG 135	BIG NEW
PAG 119	BINARIO 48Vdc
PAG 105	BINARIO SITRACK 230V
PAG 51	DOT
PAG 131	DROP
PAG 141	ELISEO
PAG 35	LIGHT CUT
PAG 139	LINE
PAG 43	LINEA
PAG 29	LINEAR SYSTEM
PAG 101	LUXOR
PAG 71	MATRIX
PAG 55	NET
PAG 59	NET SC
PAG 67	PLANA INCASSO - SEMINCASSO
PAG 103	PLANA BINARIO
PAG 127	PLANA PLAFONE-SOSPENSIONE
PAG 133	QUADRANT
PAG 147	ROSS
PAG 103	ROSS BINARIO
PAG 67	ROSS INCASSO
PAG 23	RULED
PAG 91	RULED LINEAR IP BINARIO
PAG 65	RULED LINEAR IP INCASSO
PAG 127	RULED LINEAR IP SOSPENSIONE
PAG 145	SD-HIGHBAY
PAG 47	SHELF
PAG 97	SHORT
PAG 63	SINDI
PAG 129	SINDI PLAFONE
PAG 101	SIRIUS
PAG 99	SOLARIS BINARIO
PAG 149	SONUS LINE
PAG 137	STARGATE
PAG 55	STEP
PAG 87	STILO
PAG 83	STILO 60 BASE INCASSO
PAG 81	STILO INCASSO
PAG 57	SWING
PAG 129	SWING PLAFONE
PAG 83	TOR
PAG 11	TRAIL
PAG 17	TRAIL SITRACK
PAG 99	VEGA BINARIO

ESTERNI - OUTDOOR

PAG 241	ACCESSORI PALO
PAG 217	APPLY
PAG 247	CEILING
PAG 251	CERKIO
PAG 213	CUBE
PAG 235	DOUBLELIGHT
PAG 275	ELLE
PAG 239	ELLE PARETE
PAG 163	EYES
PAG 171	EYES GROUND
PAG 251	FENIX
PAG 217	FRISBEE WALL
PAG 273	FRISBEE
PAG 203	JOGGER
PAG 199	LEDLINE
PAG 197	LONGLIGHT
PAG 191	LONGLIGHT GROUND
PAG 233	MINI MONO
PAG 235	MONO DOUBLE
PAG 253	MISTRAL
PAG 235	MONOLIGHT
PAG 251	MOON
PAG 203	NEOS
PAG 213	NEW GREEN
PAG 203	OLODUM
PAG 179	OLODUM CEILING
PAG 257	Q8
PAG 237	QUADRO DOUBLE
PAG 237	QUADRO MONO
PAG 251	QUARTO DI SFERA
PAG 227	REEF
PAG 207	RIQUADRO
PAG 257	ROK
PAG 211	RULED LINEAR IP PARETE
PAG 245	RULED LINEAR IP PLAFONE
PAG 229	RULED LINEAR IP PROIETTORE
PAG 207	SMALL-BLADE
PAG 239	SOLARIS
PAG 277	SOLARIS RESIDENZIALE
PAG 253	SOLID
PAG 221	SPOT
PAG 271	SPOT 50-TRIS
PAG 215	VARIANT
PAG 259	VERSO

Indice per tipologia installativa

Installation's index

INSIDE

OUTSIDE

PAG 8	LUCE CONTROLLATA CONTROLLED LIGHT EMISSION			MICRO INCASSI PLAFONE - PARETE - TERRA RECESSED CEILING - WALL - INGROUND	PAG 160
PAG 26	SISTEMI LINEARI MODULARI MODULAR LINEAR SYSTEMS			INCASSI PLAFONE CEILING RECESSED SPOT	PAG 176
PAG 44	INCASSI SPOT RECESSED SPOT			TERRA CALPESTABILI E CARRABILI WALK- AND DRIVEOVER INGROUND SPOT	PAG 182
PAG 52	INCASSI DOWNLIGHT RECESSED DOWNLIGHT			LINEARI TERRA - PARETE SURFACE AND WALL LINEAR	PAG 194
PAG 68	INCASSI MULTIOTTICA RECESSED MULTI-OPTICS			INCASSI PARETE SEGNAPASSO WALL RECESSED STEPLIGHTS	PAG 200
PAG 76	INCASSI ORIENTABILI RECESSED ADJUSTABLE			DECORATIVO PARETE DECORATIVE WALL LIGHTS	PAG 208
PAG 84	PROIETTORI & BINARIO SPOTS AND TRACK			PROIETTORI PROJECTORS	PAG 218
PAG 118	PROIETTORI & BINARIO 48Vdc SPOTS AND TRACK 48Vdc			PARETE - PLAFONE CEILING - WALL	PAG 230
PAG 124	PARETE - PLAFONE - SOSPENSIONE WALL-SURFACE AND SUSPENSION			PALI - ACCESSORI MONTAGGIO POLE - MOUNTING ACCESSORIES	PAG 240
PAG 142	FUNZIONALI - GRANDI AMBIENTI FUNCTIONAL LIGHTING			PLAFONE - SOSPENSIONE CEILING - SUSPENSION	PAG 242
PAG 148	PANNELLI FONOASSORBENTI CON CORPI ILLUMINANTI ACOUSTIC PANELS WITH LIGHT	SONUSLINE 		PARETE RESIDENZIALE RESIDENTIAL WALL LIGHTS	PAG 248
				BOLLARDS URBANO RESIDENZIALE URBAN RESIDENTIAL BOLLARDS	PAG 254

APPARECCHI DA INTERNO
INDOOR LIGHTING



**LUCE CONTROLLATA
CONTROLLED LIGHT EMISSION**



TRAIL INCASSO



TRAIL INCASSO



LUNGHEZZE - LENGTHS	UGR	DALI
1 LED 44 x 44 mm		a richiesta on request
3 LED 44 x 92,5 mm		
6 LED 44 x 168,5 mm	UGR <13	DALI
9 LED 44 x 244,5 mm		
12 LED 44 x 321 mm		

TRAIL PLAFONE



LUNGHEZZE - LENGTHS	UGR	DALI
1000 mm		
1250 mm	UGR <13	a richiesta on request
1500 mm		DALI
1060 mm		
1560 mm		
2060 mm		

TRAIL SOSPENSIONE

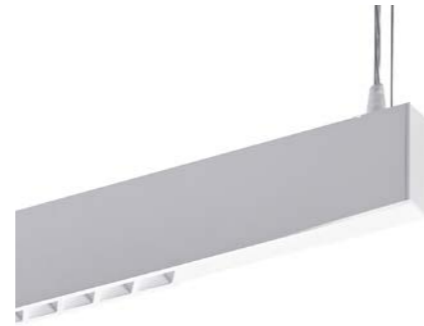

A richiesta: **KIT BEND MICRO** con driver da inserire ai lati dell'apparecchio (n. 2 spot max)
Upon request: **KIT BEND MICRO** with driver to be inserted on the lamp side (max. 2 lamps)



TRAIL SITRACK



LUNGHEZZE - LENGTHS	UGR	DALI
1000 mm		
1250 mm	UGR <13	a richiesta on request
1500 mm		DALI
1060 mm		
1560 mm		
2060 mm		



FASCIO CONTROLLATO CONTROLLED BEAM
FASCIO DIFFONDENTE DIFUSED BEAM
A RICHIESTA: PREDISPOSIZIONE PER FILE CONTINUE
ON REQUEST: SETTING FOR CONTINUOUS LINES INSTALLATION

TRAIL

RULED T13
foro 129mm



RULED T15
foro 145mm



RULED T20
foro 190mm



RULED T20 9 LED
foro 190mm



RULED

RULED Q10
foro 93x93 mm



RULED Q14
foro 136x136 mm



FOOD	DALI	EMERGENZA EMERGENCY	UGR
a richiesta - on request			
FOOD	DALI	EM	UGR <19

OTTICHE - BEAMS

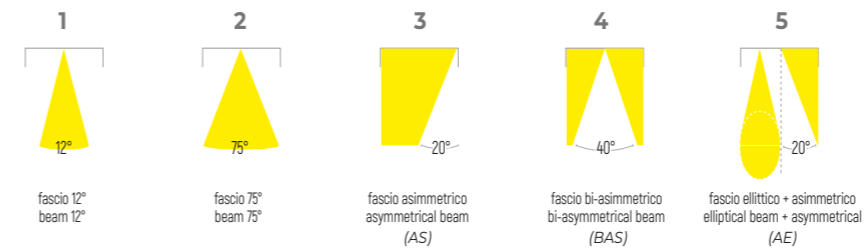

Custom 1
BASSA E ALTA POTENZA
LOW AND HIGH POWER

Custom 2
OTTICHE COMBINABILI
OPTIC MIX

Custom 3
COLORE VETRO
GLASS COLOR

Custom 4
COLORE GHIERA
RING COLOR



LUCE CONTROLLATA - CONTROLLED LIGHT EMISSION



CODICE CODE	DESCRIZIONE DESCRIPTION	FASCIO BEAM	COLORE FINISH	
3710-LBC/LBN	TRAIL INCASSO foro 36x38,5mm 3W 125Lm 500mA - 1 LED	25°	BR	
3711-LBC/LBN			NE	
3712-LBC/LBN			GR	
3716-LBC/LBN	TRAIL INCASSO foro 36x86,5mm 5,5W 360Lm 500mA - 3 LED	25°	BR	
3717-LBC/LBN			NE	
3718-LBC/LBN			GR	
3719-LBC/LBN	TRAIL INCASSO foro 36x162,5mm 10W 850Lm 500mA - 6 LED	25°	BR	
3720-LBC/LBN			NE	
3721-LBC/LBN			GR	
3722-LBC/LBN	TRAIL INCASSO foro 36x236,5mm 15,5W 1100Lm 500mA - 9 LED	25°	BR	
3723-LBC/LBN			NE	
3724-LBC/LBN			GR	
3725-LBC/LBN	TRAIL INCASSO foro 36x314mm 21W 1600Lm 500mA - 12 LED	25°	BR	
3726-LBC/LBN			NE	
3727-LBC/LBN			GR	
3730-LBC/LBN-P	TRAIL PLAFONE L.1000mm - 21W 1600Lm 500mA - FASCIO CONTROLLATO - CONTROLLED BEAM	25x25°	BR	
3730-LBC/LBN-P-NE			NE	
3733-LBC/LBN-P	TRAIL PLAFONE L.1250mm - 40W 3200Lm 500mA - FASCIO CONTROLLATO - CONTROLLED BEAM	25x25°	BR	
3733-LBC/LBN-P-NE			NE	
3736-LBC/LBN-P	TRAIL PLAFONE L.1500mm - 58W 4800Lm 500mA - FASCIO CONTROLLATO - CONTROLLED BEAM	25x25°	BR	
3736-LBC/LBN-P-NE			NE	
3190-LBC/LBN	KIT BEND MICRO 6,5W 570Lm 220V	-	BR	
3190-LBC/LBN-NE			NE	
3740-LBC/LBN-P	TRAIL PLAFONE L.1060mm - 31W 1800Lm 220-240V 24V - FASCIO DIFFONDEnte - DIFFUSED BEAM	120°	BR	
3740-LBC/LBN-P-NE			NE	
3743-LBC/LBN-P	TRAIL PLAFONE L.1560mm - 44,2W 2700Lm 220-240V 24V - FASCIO DIFFONDEnte - DIFFUSED BEAM	120°	BR	
3743-LBC/LBN-P-NE			NE	
3746-LBC/LBN-P	TRAIL PLAFONE L.2060mm - 58W 3600Lm 220-240V 24V - FASCIO DIFFONDEnte - DIFFUSED BEAM	120°	BR	
3746-LBC/LBN-P-NE			NE	
3193	Adattatore per binario 3 fasi, venduto già montato sull'apparecchio	-	BR	
3193-NE	Adaptor for three phases track already mounted on the fitting	-	NE	
3194	Kit attacco parete - Kit for wall installation 65x30mm	-	BR	
3194-NE		-	NE	

TRAIL INCASSO



TRAIL PLAFONE

FASCIO CONTROLLATO - CONTROLLED BEAM

FASCIO DIFFONDEnte - DIFUSED BEAM

LUCE CONTROLLATA - CONTROLLED LIGHT EMISSION

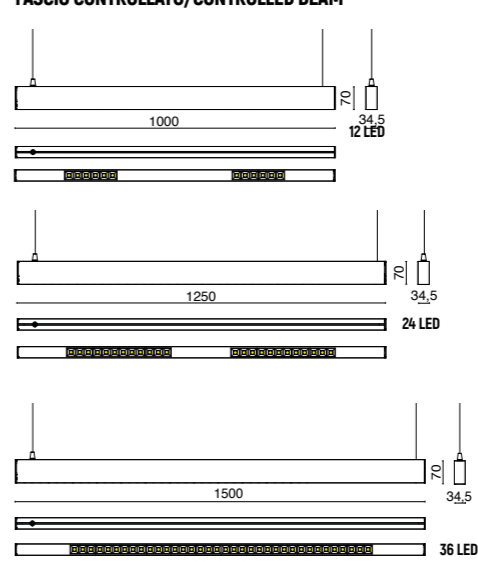
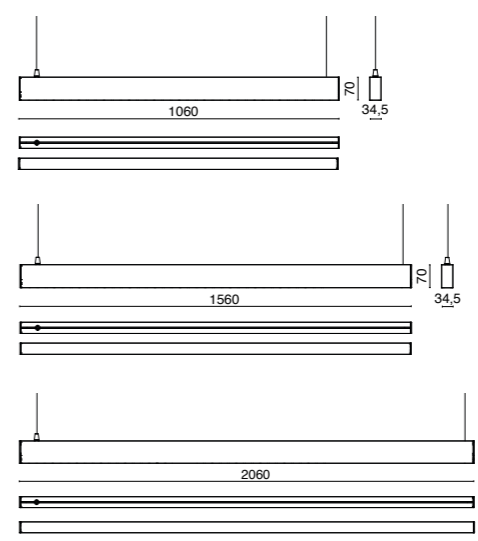

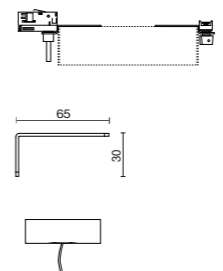
CODICE CODE	DESCRIZIONE DESCRIPTION	FASCIO BEAM	COLORE FINISH		
3730-LBC/LBN-S	TRAIL SOSPENSIONE L.1000mm - 21W 1600Lm 500mA - FASCIO CONTROLLATO - CONTROLLED BEAM	25x25°	BR	<p>TRAIL SOSPENSIONE</p>  <p>FASCIO CONTROLLATO/CONTROLLED BEAM</p>  <p>FASCIO DIFFONDEnte/DIFUSED BEAM</p>  <p>IP 20  DALI</p> <p>a richiesta on request</p>	
3730-LBC/LBN-S-NE			NE		
3733-LBC/LBN-S	TRAIL SOSPENSIONE L.1250mm - 40W 3200Lm 500mA - FASCIO CONTROLLATO - CONTROLLED BEAM	25x25°	BR		
3733-LBC/LBN-S-NE			NE		
3736-LBC/LBN-S	TRAIL SOSPENSIONE L.1500mm - 58W 4800Lm 500mA - FASCIO CONTROLLATO - CONTROLLED BEAM	25x25°	BR		
3736-LBC/LBN-S-NE			NE		
3190-LBC/LBN	KIT BEND MICRO 6,5W 570Lm 220V	-	BR		
3190-LBC/LBN-NE			NE		
3740-LBC/LBN-S	TRAIL SOSPENSIONE L.1060mm - 31W 1800Lm 220-240V 24V - FASCIO DIFFONDEnte - DIFFUSED BEAM	120°	BR		
3740-LBC/LBN-S-NE			NE		
3743-LBC/LBN-S	TRAIL SOSPENSIONE L.1560mm - 44,2W 2700Lm 220-240V 24V - FASCIO DIFFONDEnte - DIFFUSED BEAM	120°	BR		
3743-LBC/LBN-S-NE			NE		
3746-LBC/LBN-S	TRAIL SOSPENSIONE L.2060mm - 58W 3800Lm 220-240V 24V - FASCIO DIFFONDEnte - DIFFUSED BEAM	120°	BR		
3746-LBC/LBN-S-NE			NE		
3193	ACCESSORI - ACCESSORIES	-	BR		
3193-NE	Adattatore per binario 3 fasi, venduto già montato sull'apparecchio Adaptor for three phases track already mounted on the fitting	-	NE		
3194	Kit attacco parete 65x30 - Kit for wall installation	-	BR		
3194-NE			NE		
3191	Rosone - Canopy	-	BR		
3191-NE			NE		



TRAILSITRACK

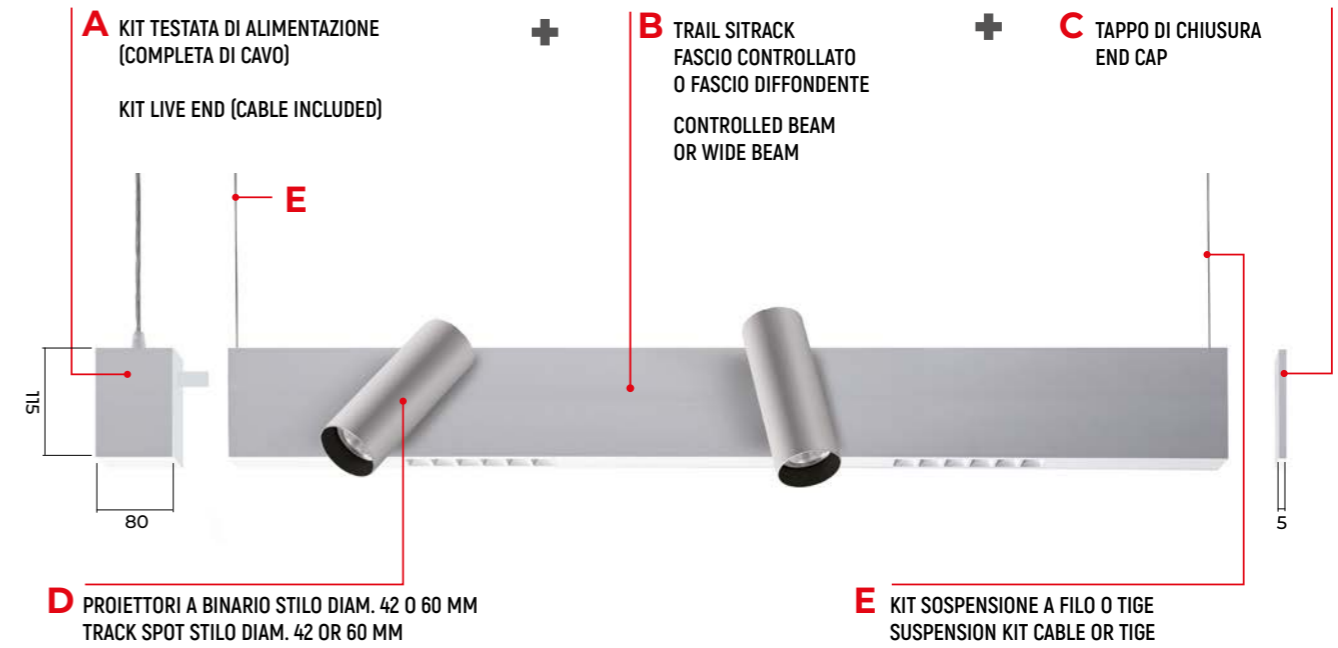

ESEMPIO DI ORDINE - ORDER EXAMPLE

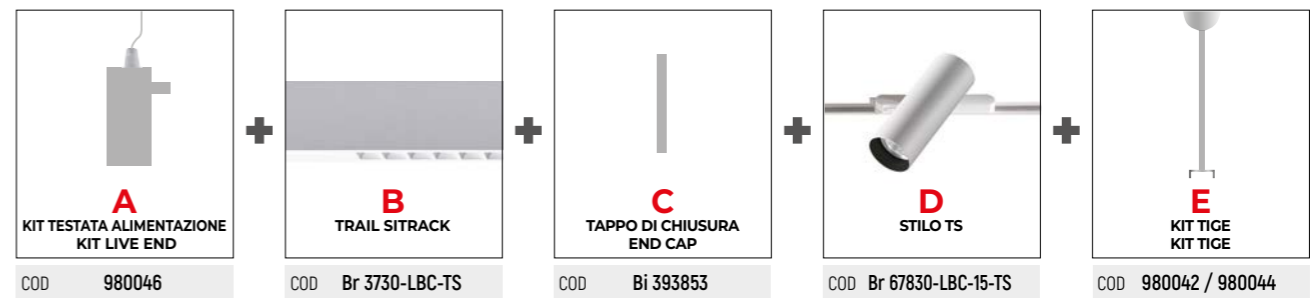

A richiesta apparecchio con cavo per file continue - on request fitting for in line installation COD/FC

LUCE CONTROLLATA - CONTROLLED LIGHT EMISSION



CODICE CODE	DESCRIZIONE DESCRIPTION	FASCIO BEAM	COLORE FINISH
3730-LBC/LBN-TS	TRAIL SITRACK L.1000mm - 21W 1600Lm 500mA - FASCIO CONTROLLATO - CONTROLLED BEAM	25x25°	BR
3733-LBC/LBN-TS	TRAIL SITRACK L.1250mm - 40W 3200Lm 500mA - FASCIO CONTROLLATO - CONTROLLED BEAM	25x25°	BR
3736-LBC/LBN-TS	TRAIL SITRACK L.1500mm - 58W 4800Lm 500mA - FASCIO CONTROLLATO - CONTROLLED BEAM	25x25°	BR
3740-LBC/LBN-TS	TRAIL SITRACK L.1060mm - 31W 1800Lm 220-240V 24V - FASCIO DIFFONDENTE - DIFFUSED BEAM	120°	BR
3743-LBC/LBN-TS	TRAIL SITRACK L.1560mm - 44,2W 2700Lm 220-240V 24V - FASCIO DIFFONDENTE - DIFFUSED BEAM	120°	BR
3746-LBC/LBN-TS	TRAIL SITRACK L.2060mm - 58W 3800Lm 220-240V 24V - FASCIO DIFFONDENTE - DIFFUSED BEAM	120°	BR

B FASCIO CONTROLLATO - CONTROLLED BEAM

TRAIL SITRACK

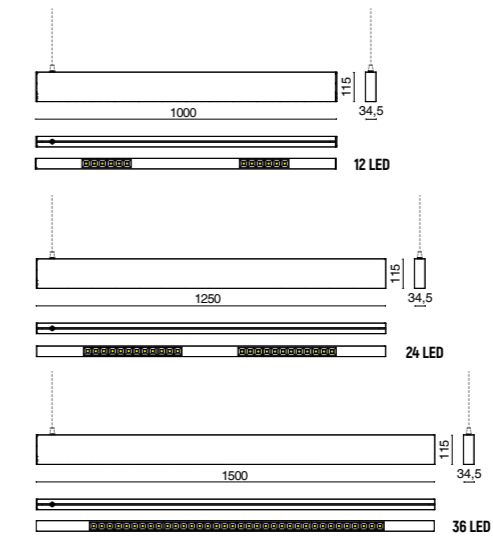
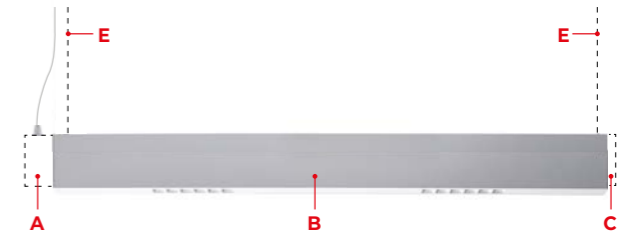

Proiettori **STILO** non compresi
Stilo track spot not included
Kit sospensione non compresi
Suspension kit not included





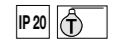
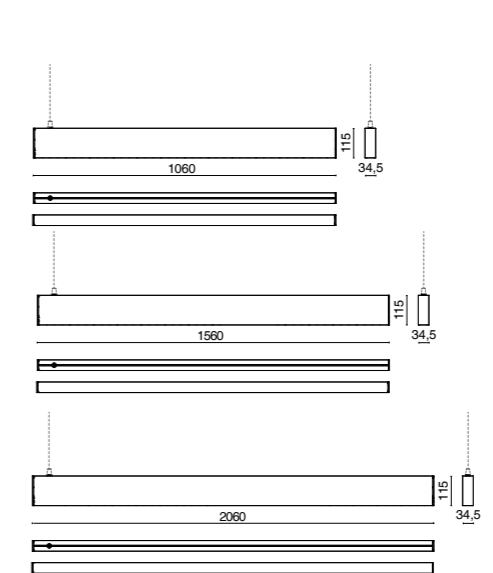
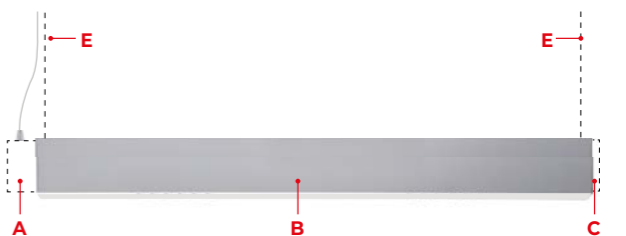

B FASCIO DIFFONDENTE - DIFUSED BEAM



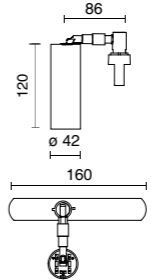

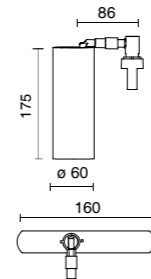

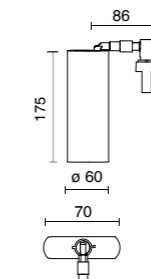



LUCE CONTROLLATA - CONTROLLED LIGHT EMISSION

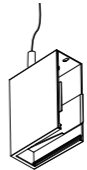

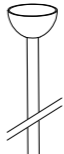
CODICE CODE	DESCRIZIONE DESCRIPTION	FASCIO BEAM	COLORE FINISH	ACCESSORI - ACCESSORIES SITRACK
67830-LBC/LBN-15/24/36-TS	<p>STILO Ø 42 14W 1200Lm 350mA VERSIONE PER BINARIO CON ADATTATORE SLIM VERSION FOR TRACK WITH SLIM ADAPTER</p>	15 - 24 - 38°	BR	<p>D VERSIONE PER BINARIO CON ADATTATORE SLIM VERSION FOR TRACK WITH SLIM ADAPTER</p> <p>STILO Ø 42</p>  
67831-LBC/LBN-15/24/36-TS			NE	
67840-LBC/LBN-6/19/27/38/56-TS	<p>STILO Ø 60 22,5W 1800Lm 500mA VERSIONE PER BINARIO CON ADATTATORE SLIM - Driver integrato nell'attacco a binario VERSION FOR TRACK WITH SLIM ADAPTER - Driver integrated in the rail attack</p>	6 - 19 - 27 38 - 56°	BR	<p>D VERSIONE PER BINARIO CON ADATTATORE SLIM VERSION FOR TRACK WITH SLIM ADAPTER Driver integrato nell'attacco a binario Driver integrated in the rail attack</p> <p>STILO Ø 60</p>  
67841-LBC/LBN-6/19/27/38/56-TS			NE	
67883-LBC/LBN-6/19/27/38/56-TS	<p>STILO Ø 60 22,5W 1800Lm 500mA VERSIONE PER BINARIO SITRACK TRIFASE 230V - Driver integrato nel corpo dell'apparecchio VERSION FOR SITRACK TRIPHASE 230V TRACK - Driver integrated in the body of the fitting</p>	6 - 19 - 27 38 - 56°	BR	<p>D VERSIONE PER BINARIO SITRACK TRIFASE 230V VERSION FOR SITRACK TRIPHASE 230V TRACK Driver integrato nel corpo dell'apparecchio Driver integrated in the body of the fitting</p> 
67884-LBC/LBN-6/19/27/38/56-TS			NE	

LUCE CONTROLLATA - CONTROLLED LIGHT EMISSION



CODICE CODE	DESCRIZIONE DESCRIPTION	COLORE FINISH		ACCESSORI - ACCESSORIES SITRACK
980046	A Kit testata sinistra di alimentazione con cavo - Kit left live end with cable	BI	A	
980047	A Kit testata destra di alimentazione con cavo - Kit right live end with cable	BI		
393853	C Tappo di chiusura - End cap	BI	C	
980042	E KIT Tige con rosone per montaggio a sospensione - Kit tige with canopy for pendant mounting L= 600 mm.	BI	E	
980044	E KIT Tige con rosone per montaggio a sospensione - Kit tige with canopy for pendant mounting L= 1200 mm.	BI		
990371	Congiunzione elettrica per file continue Straight coupler for in line installation	-		
980049	Kit congiunzione meccanica per file continue Mechanical coupler kit for in line installation	-		
646650	Cavi di connessione per file continue - Connection cables for in line installation L= 1000 mm.	-		
646651	Cavi di connessione per file continue - Connection cables for in line installation L= 1250 mm.	-		
646652	Cavi di connessione per file continue - Connection cables for in line installation L= 1500 mm.	-		
646653	Cavi di connessione per file continue - Connection cables for in line installation L= 2000 mm.	-		
990341	Copribinario - Track cover L= 1000 mm.	BI		

LUCE CONTROLLATA - CONTROLLED LIGHT EMISSION



CODICE CODE	DESCRIZIONE DESCRIPTION	FASCIO BEAM	COLORE FINISH				
KT5800LBC/LBN12/75/AS/BAS/AE	RULED T13 foro ø126mm 14W da 800 a 1600Lm 500mA + DRIVER	12 - 75° - AS BAS - AS+ELL	BR		RULED T13 		
KT5801LBC/LBN12/75/AS/BAS/AE			NE				
KT5805LBC/LBN12/75/AS/BAS/AE	RULED T13 foro ø126mm 42,5W da 1700 a 3500Lm 800mA + DRIVER	12 - 75° - AS BAS - AS+ELL	BR				
KT5806LBC/LBN12/75/AS/BAS/AE			NE			foro 129mm 	a richiesta - on request
KT5820LBC/LBN12/75/AS/BAS/AE	RULED T15 foro ø145mm 18W da 1100 a 2000Lm 650mA + DRIVER	12 - 75° - AS BAS - AS+ELL	BR		RULED T15 		
KT5821LBC/LBN12/75/AS/BAS/AE			NE				
KT5825LBC/LBN12/75/AS/BAS/AE	RULED T15 foro ø145mm 42,5W da 1700 a 3500Lm 800mA + DRIVER	12 - 75° - AS BAS - AS+ELL	BR				
KT5826LBC/LBN12/75/AS/BAS/AE			NE			foro 145mm 	a richiesta - on request
KT5840LBC/LBN12/75/AS/BAS/AE	RULED T20 foro ø190mm 23W da 1200 a 2500Lm 800mA + DRIVER - 4LED	12 - 75° - AS BAS - AS+ELL	BR		RULED T20 		
KT5841LBC/LBN12/75/AS/BAS/AE			NE			foro 190mm 	a richiesta - on request
KT5845LBC/LBN12/75/AS/BAS/AE	RULED T20 foro ø190mm 34W da 1800 a 3500Lm 1200mA + DRIVER - 9LED	12 - 75° - AS BAS - AS+ELL	BR				RULED T20 - 9 LED
KT5846LBC/LBN12/75/AS/BAS/AE			NE				
KT5850LBC/LBN12/75/AS/BAS/AE	RULED T20 foro ø190mm 47W da 2700 a 5200Lm 1750mA + DRIVER - 9LED PLUS	12 - 75° - AS BAS - AS+ELL	BR				
KT5851LBC/LBN12/75/AS/BAS/AE			NE	foro 190mm 	a richiesta - on request 		

LUCE CONTROLLATA - CONTROLLED LIGHT EMISSION



CODICE CODE	DESCRIZIONE DESCRIPTION	FASCIO BEAM	COLORE FINISH		
KT5870LBC/LBN-12/75/AE	RULED Q10 foro 93x93mm 14W da 1100 a 1600Lm 500mA + DRIVER	12 - 75° AS+ELL	BR		<p>RULED Q10</p>
KT5871LBC/LBN-12/75/AE			NE		
KT5880LBC/LBN-12/75/AE/AS	RULED Q14 foro 136x136mm 18W da 1100 a 1500Lm 650mA + DRIVER	12 - 75° - AS AS+ELL	BR		<p>RULED Q14</p>
KT5881LBC/LBN-12/75/AE/AS			NE		

LINEARI MODULARI - MODULAR LINEAR
SISTEMI LINEARI MODULARI - MODULAR LINEAR SYSTEM



LINEAR SYSTEM

LINEAR SYSTEM

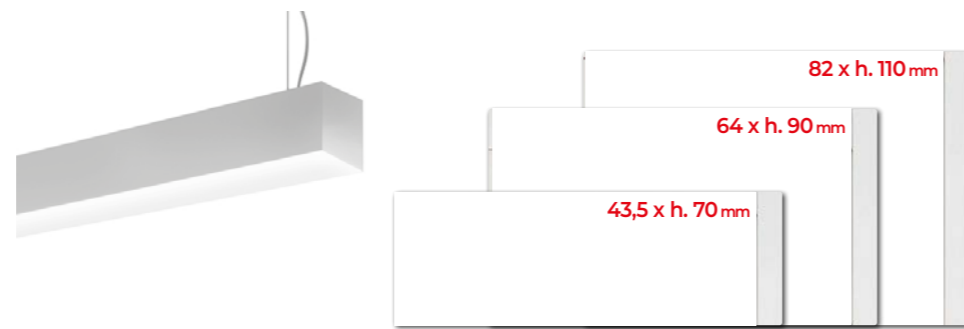

**SISTEMA
 FILA CONTINUA MODULARE
 CONTINUOUS MODULAR SYSTEM**



LUNGHEZZE - LENGHTS

855 mm
 1415 mm
 1975 mm
 2815 mm

**INCASSO
 RECESSED**

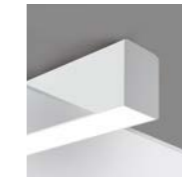

UGR



**PLAFONE
 SURFACE**

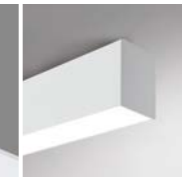

DALI



**PARETE
 WALL**

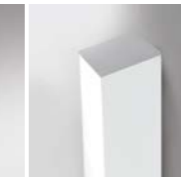

**SOSPENSIONE
 SUSPENSION**

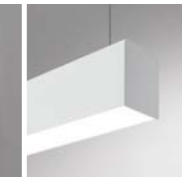

**LUCE DIRETTA E INDIRECTA
 SIMMETRICA O ASIMMETRICA
 SUSPENSION DIRECT/INDIRECT
 SYMMETRIC OR ASYMMETRIC**



NEW LIGHT CUT

STRIP da 22W/m - 44W/m

LIGHT CUT

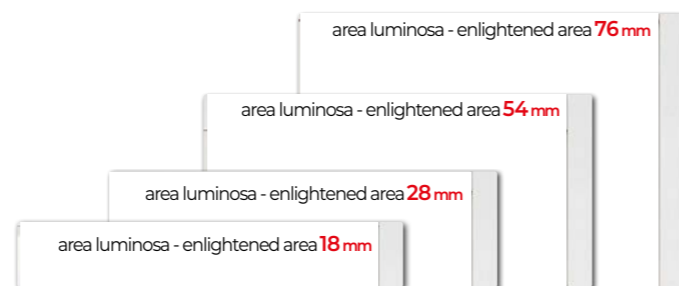

LIGHT CUT 20 □ foro 22 x L + 4mm

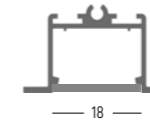

18

LIGHT CUT 30

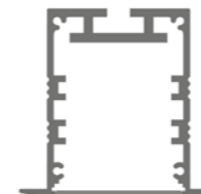

28

**BATTUTA
 FRAME**

□ foro 32 x L + 4mm



28

**SENZA CORNICE
 TRIMLESS**

□ foro 32 x L + 4mm



28

**ANGOLARE SENZA CORNICE
 CORNER TRIMLESS**

□ foro 32 x L + 6mm

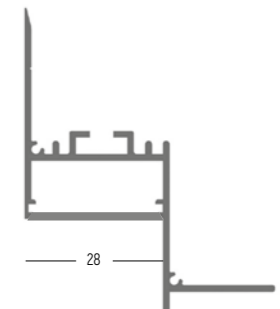

28

**ANGOLARE LUCE RETROCESSA
 CORNER RECESSED LIGHT**

□ foro 32 x L + 6mm

LIGHT CUT 55 □ foro 55 x L + 6mm

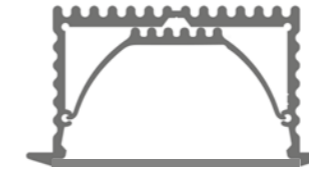

54

LIGHT CUT 75 □ foro 88 x L + 7mm



76

LINEA

da 40,2 a 76,5W
 da 5800Lm a 12000Lm

NEW FOR GDO
 LARGE-SCALE RETAIL TRADE

LINEA



**LUNGHEZZE
 LENGHTS**
 1415 mm
 2820 mm

UGR



DALI

a richiesta
 on request



**EMERGENZA
 EMERGENCY**

a richiesta
 on request



FOOD

a richiesta
 on request



**ILLUMINARE LO SPAZIO IN
 LIGHTING SPACE IN 3 CLICK**

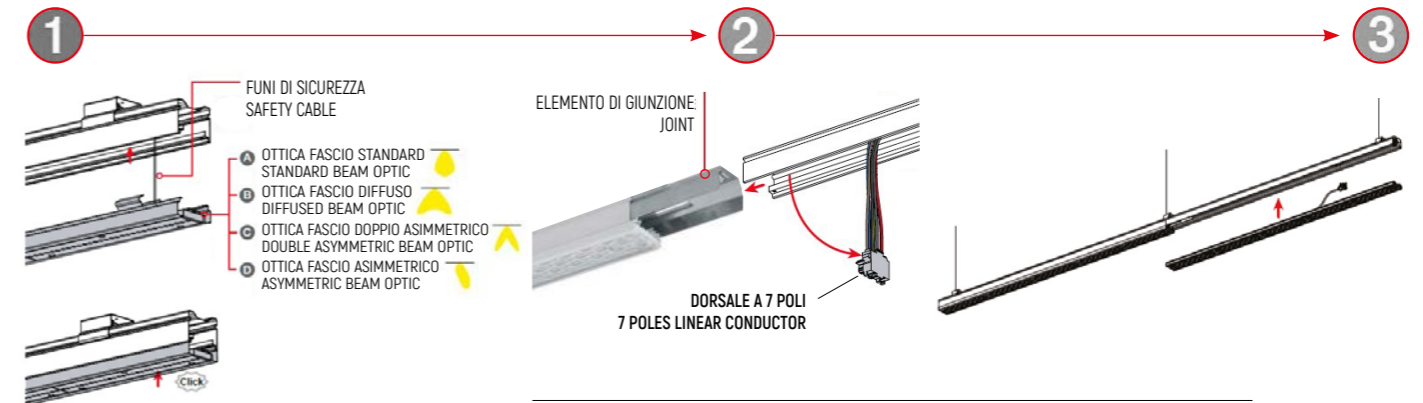

APPARECCHIO PREDISPOSTO PER FILE CONTINUE - LUMINAIRE PRE-SET FOR CONTINUOUS LINES INSTALLATION

LINEAR SYSTEM SISTEMI LINEARI MODULARI - MODULAR LINEAR SYSTEM



CODICE
CODE

DESCRIZIONE
DESCRIPTION

FASCIO
BEAM

COLORE
FINISH

LINEAR SYSTEM larghezza - width **43 x h. 70mm** SISTEMA AMPLIABILE COMPONIBILE - MODULAR SYSTEM

LINEAR SYSTEM
larghezza - width **43 x h. 70mm**

3350-LBC/LBN-D9	L.850mm 30W 2400Lm 500mA	SIM	DIRETTO	BR
3351-LBC/LBN-D9		SIM	DIRETTO	NE
3350-LBC/LBN-DE9	L.850mm 30W 2400Lm DIRETTO + 9W 800Lm INDIRETTO 500mA	SIM	DIRETTO/INDIRETTO	BR
3351-LBC/LBN-DE9		SIM	DIRETTO/INDIRETTO	NE
3350-LBC/LBN-D14	L.1410mm 47W 4000Lm 500mA	SIM	DIRETTO	BR
3351-LBC/LBN-D14		SIM	DIRETTO	NE
3350-LBC/LBN-DE14	L.1410mm 47W 4000Lm DIRETTO + 17W 1800Lm INDIRETTO 500mA	SIM	DIRETTO/INDIRETTO	BR
3351-LBC/LBN-DE14		SIM	DIRETTO/INDIRETTO	NE
3350-LBC/LBN-D19	L.1970mm 64W 5600Lm 500mA	SIM	DIRETTO	BR
3351-LBC/LBN-D19		SIM	DIRETTO	NE
3350-LBC/LBN-DE19	L.1970mm 68W 5600Lm DIRETTO + 25W 2700Lm INDIRETTO 500mA	SIM	DIRETTO/INDIRETTO	BR
3351-LBC/LBN-DE19		SIM	DIRETTO/INDIRETTO	NE
3350-LBC/LBN-D28	L.2810mm 90W 8000Lm 500mA	SIM	DIRETTO	BR
3351-LBC/LBN-D28		SIM	DIRETTO	NE
3350-LBC/LBN-DE28	L.2810mm 94W 8000Lm DIRETTO + 34W 3600Lm INDIRETTO 500mA	SIM	DIRETTO/INDIRETTO	BR
3351-LBC/LBN-DE28		SIM	DIRETTO/INDIRETTO	NE
3354-LBC/LBN-A	Modulo angolare incasso/plafone 20W 1600Lm 500mA	SIM	DIRETTO	BR
3355-LBC/LBN-A		SIM	DIRETTO	NE
3354-LBC/LBN-AM	Modulo angolare incasso/plafone 20W 1600Lm 500mA	SIM	DIRETTO	BR
3355-LBC/LBN-AM		SIM	DIRETTO	NE
980016-I-43	ACCESSORI - ACCESSORIES KIT FISSAGGIO A INCASSO - KIT FOR RECESSED INSTALLATION (cartongesso/plasterboard $\Delta = \pm 10\text{mm}$)	-	-	-
980017-P-43	KIT FISSAGGIO A PARETE - KIT FOR WALL INSTALLATION	-	-	-
980012-S-43	KIT SOSPENSIONE A FILO - KIT CABLE SUSPENSION - ϕ 1,2 mm - L. 3 m	-	-	-
980019	KIT DI GIUNZIONE ELETTROMECCANICA - JUNCTION KIT	-	-	-
699907	KIT BLOCCACAVO SOSPENSIONE - KIT CANOPY (rosone/canopy)	-	-	BR
980052		-	-	NE
98001306-T-43	KIT N. 2 TESTATE DI CHIUSURA (alluminio senza viti a vista) - KIT END CAP without screws	-	-	BR
98001307-T-43		-	--	NE

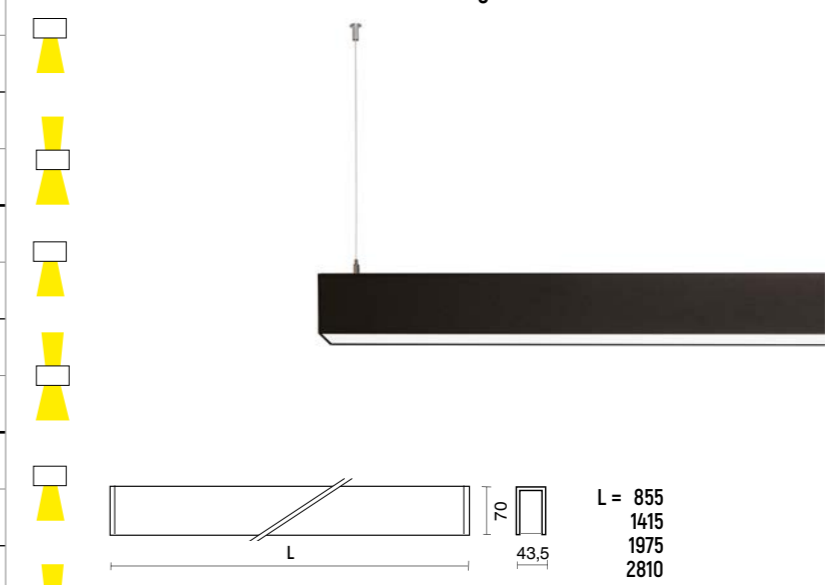

A richiesta:
Doppia accensione indipendente ON-OFF.
Doppia accensione indipendente DALI (gestita dalla console DALI).

On request:
Independent ON-OFF double switching.
Independent DALI double switching (controlled through DALI console).

IP 20 a richiesta on request

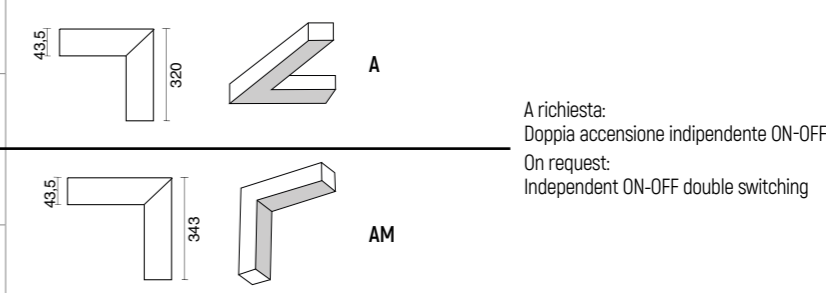

A richiesta:
Doppia accensione indipendente ON-OFF
On request:
Independent ON-OFF double switching

LINEAR SYSTEM SISTEMI LINEARI MODULARI - MODULAR LINEAR SYSTEM



CODICE CODE DESCRIZIONE DESCRIPTION FASCIO BEAM COLORE FINISH

LINEAR SYSTEM larghezza - width 64 x h. 90mm SISTEMA AMPLIABILE COMPONIBILE - MODULAR SYSTEM

LINEAR SYSTEM larghezza - width 64 x h. 90mm

3360-LBC/LBN-D9	L.850mm 30W 2200Lm 500mA - SIMMETRICO - SYMMETRIC	SIM	DIRETTO	BR
3361-LBC/LBN-D9		SIM	DIRETTO	NE
3360BC/BN-D9-AS	L.850mm 30W 2200Lm 500mA - SIMMETRICO - SYMMETRIC	ASIM	DIRETTO	BR
3361BC/BN-D9-AS		ASIM	DIRETTO	NE
3360-LBC/LBN-DE9	L.850mm 30W 2200Lm DIRETTO + 9W 1000Lm INDIRETTO 500mA	SIM	DIRETTO-INDIRETTO	BR
3361-LBC/LBN-DE9		SIM	DIRETTO-INDIRETTO	NE
3360-LBC/LBN-D14	L.1410mm 47W 3900Lm 500mA - SIMMETRICO - SYMMETRIC	SIM	DIRETTO	BR
3361-LBC/LBN-D14		SIM	DIRETTO	NE
3360BCD/BN-D14-AS	L.1410mm 47W 3900Lm 500mA - ASIMMETRICO - ASYMMETRIC	ASIM	DIRETTO	BR
3361BCD/BN-D14-AS		ASIM	DIRETTO	NE
3360-LBC/LBN-DE14	L.1410mm 47W 4000Lm DIRETTO 17W 2000Lm INDIRETTO 500mA	SIM	DIRETTO-INDIRETTO	BR
3361-LBC/LBN-DE14		SIM	DIRETTO-INDIRETTO	NE
3360-LBC/LBN-D19	L.1970mm 68W 5000Lm 500mA - SIMMETRICO - SYMMETRIC	SIM	DIRETTO	BR
3361-LBC/LBN-D19		SIM	DIRETTO	NE
3360BCD/BN-D19-AS	L.1970mm 68W 5000Lm 500mA - ASIMMETRICO - ASYMMETRIC	ASIM	DIRETTO	BR
3361BCD/BN-D19-AS		ASIM	DIRETTO	NE
3360-LBC/LBN-DE19	L.1970mm 68W 4000Lm DIRETTO + 25W 2900Lm INDIRETTO 500mA	SIM	DIRETTO-INDIRETTO	BR
3361-LBC/LBN-DE19		SIM	DIRETTO-INDIRETTO	NE
3360-LBC/LBN-D28	L.2810mm 94W 7800Lm 500mA - SIMMETRICO - SYMMETRIC	SIM	DIRETTO	BR
3361-LBC/LBN-D28		SIM	DIRETTO	NE
3360BC/BN-D28-AS	L.2810mm 94W 7800Lm 500mA - ASIMMETRICO - ASYMMETRIC	ASIM	DIRETTO	BR
3361BC/BN-D28-AS		ASIM	DIRETTO	NE
3360-LBC/LBN-DE28	L.2810mm 94W 8000Lm DIRETTO + 34W 3800Lm INDIRETTO 500mA	SIM	DIRETTO-INDIRETTO	BR
3361-LBC/LBN-DE28		SIM	DIRETTO-INDIRETTO	NE
3364-LBC/LBN-A	Modulo angolare incasso/plafone - Ceiling/Recessed flat corner module - 20W 1600Lm 500mA	SIM	DIRETTO	BR
3365-LBC/LBN-A		SIM	DIRETTO	NE
3364-LBC/LBN-AM	Modulo angolare incasso/plafone - Ceiling/Recessed flat corner module - 20W 1600Lm 500mA	SIM	DIRETTO	BR
3365-LBC/LBN-AM		SIM	DIRETTO	NE
980016-I-64	ACCESSORI - ACCESSORIES KIT FISSAGGIO A INCASSO - KIT FOR RECESSED INSTALLATION (cartongesso/plasterboard $\Delta = \pm 10\text{mm}$)	-	-	-
980017-P-64	KIT FISSAGGIO A PARETE - KIT FOR WALL INSTALLATION	-	-	-
980012-S-64	KIT SOSPENSIONE A FILO - KIT CABLE SUSPENSION - $\phi 1,2\text{mm}$ - L. 3 m	-	-	-
980019	KIT DI GIUNZIONE ELETTROMECCANICA - JUNCTION KIT	-	-	-
699907	KIT BLOCCACAVO SOSPENSIONE - KIT CANOPY (rosone/canopy)	-	-	BR
980052		-	-	NE
98001306-T-64	KIT N. 2 TESTATE DI CHIUSURA (alluminio senza viti a vista) - KIT END CAP without screws	-	-	BR
98001307-T-64		-	-	NE

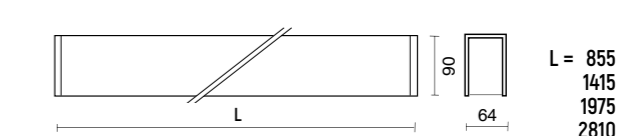

A richiesta:
Doppia accensione indipendente ON-OFF.
Doppia accensione indipendente DALI (gestita dalla console DALI).

On request:
Independent ON-OFF double switching.
Independent DALI double switching (controlled through DALI console).

IP 20 UGR 19 a richiesta on request

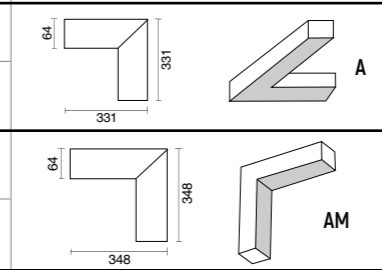

A richiesta:
Doppia accensione indipendente ON-OFF
On request:
Independent ON-OFF double switching

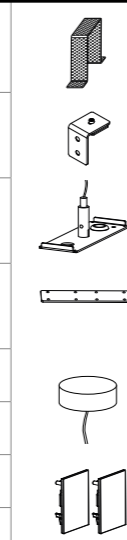

LINEAR SYSTEM SISTEMI LINEARI MODULARI - MODULAR LINEAR SYSTEM



CODICE CODE DESCRIZIONE DESCRIPTION FASCIO BEAM COLORE FINISH

LINEAR SYSTEM larghezza - width **82 x h. 110mm** SISTEMA AMPLIABILE COMPONIBILE - MODULAR SYSTEM

LINEAR SYSTEM
larghezza - width **82 x h. 110 mm**

CODICE CODE	DESCRIZIONE DESCRIPTION	FASCIO BEAM	COLORE FINISH
3380-LBC/LBN-D9	L.850mm 30W 2200Lm 500mA - SIMMETRICO - SYMMETRIC	SIM	BR
3381-LBC/LBN-D9		DIRETTO	NE
3380BC/BN-D9-AS	L.850mm 30W 2200Lm 500mA - ASIMMETRICO - ASYMMETRIC		ASIM
3381BC/BN-D9-AS			NE
3380-LBC/LBN-D9B	L.850mm 59W 4700Lm 500mA - SIMMETRICO - SYMMETRIC - 2 LED STRIPS	SIM	BR
3381-LBC/LBN-D9B		DIRETTO	NE
3380-LBC/LBN-DE9	L.850mm 30W 2200Lm DIRETTO + 9W 1000Lm INDIRETTO 500mA - DIR./IND.	SIM	BR
3381-LBC/LBN-DE9		DIRETTO-INDIRETTO	NE
3380-LBC/LBN-D14	L.1410mm 47W 3900Lm 500mA - SIMMETRICO - SYMMETRIC	SIM	BR
3381-LBC/LBN-D14		DIRETTO	NE
3380BC/BN-D14-AS	L.1410mm 47W 3900Lm 500mA - ASIMMETRICO - ASYMMETRIC		ASIM
3381BC/BN-D14-AS			NE
3380-LBC/LBN-D14B	L.1410mm 94W 7700Lm 500mA - SIMMETRICO - SYMMETRIC - 2 LED STRIPS	SIM	BR
3380-LBC/LBN-D14B		DIRETTO	NE
3380-LBC/LBN-DE14	L.1410mm 47W 4000Lm DIRETTO + 17W 2000Lm INDIRETTO 500mA - DIR./IND.	SIM	BR
3381-LBC/LBN-DE14		DIRETTO-INDIRETTO	NE
3380-LBC/LBN-D19	L.1970mm 68W 5000Lm 500mA - SIMMETRICO - SYMMETRIC	SIM	BR
3381-LBC/LBN-D19		DIRETTO	NE
3380BC/BN-D19-AS	L.1970mm 68W 5000Lm 500mA - ASIMMETRICO - ASYMMETRIC		ASIM
3381BC/BN-D19-AS			NE
3380-LBC/LBN-D19B	L.1970mm 131W 11000Lm 500mA - SIMMETRICO - SYMMETRIC - 2 LED STRIPS	SIM	BR
3380-LBC/LBN-D19B		DIRETTO	NE
3380-LBC/LBN-DE19	L.1970mm 68W 4000Lm DIRETTO + 25W 2900Lm INDIRETTO 500mA - DIR./IND.	SIM	BR
3381-LBC/LBN-DE19		DIRETTO-INDIRETTO	NE
3380-LBC/LBN-D28	L.2810mm 94W 7800Lm 500mA - SIMMETRICO - SYMMETRIC	SIM	BR
3381-LBC/LBN-D28		DIRETTO	NE
3380BC/BN-D28-AS	L.2810mm 94W 7800Lm 500mA - ASIMMETRICO - ASYMMETRIC		ASIM
3381BC/BN-D28-AS			NE
3380-LBC/LBN-D28B	L.2810mm 186W 15000Lm 500mA Simmetrico - 2 LED STRIPS	SIM	BR
3381-LBC/LBN-D28B		DIRETTO	NE
3380-LBC/LBN-DE28	L.2810mm 94W 8000Lm DIRETTO + 34W 3800Lm INDIRETTO 500mA - DIR./IND.	SIM	BR
3381-LBC/LBN-DE28		DIRETTO-INDIRETTO	NE
3384-LBC/LBN-A	Modulo angolare incasso/plafone 20W 1600Lm 500mA	SIM	BR
3385-LBC/LBN-A			NE
3384-LBC/LBN-AM	Modulo angolare a plafone/plafone 20W 1600Lm 500mA		BR
3385-LBC/LBN-AM			NE
980016-I-82	ACCESSORI - ACCESSORIES KIT FISSAGGIO A INCASSO - KIT FOR RECESSED INSTALLATION (cartongesso/plasterboard $\pm 10mm$)	-	-
980017-P-82	KIT FISSAGGIO A PARETE - KIT FOR WALL INSTALLATION	-	-
980012-S-82	KIT SOSPENSIONE A FILO - KIT SUSPENSION CABLE - $\phi 1,2 mm$ - L. 3 m	-	-
980019	KIT DI GIUNZIONE ELETTROMECCANICA - JUNCTION KIT	-	-
699907	KIT BLOCCACAVO SOSPENSIONE - KIT CANOPY (rosone/canopy)	-	BR
980052		-	NE
98001306-T-82	KIT N. 2 TESTATE DI CHIUSURA (allum senza viti a vista) - KIT END CAP (no visible screws)	-	BR
98001307-T-82		-	NE

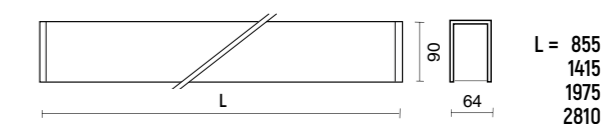





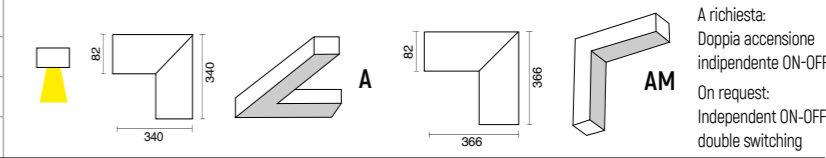

L = 855
1415
1975
2810

A richiesta:
Doppia accensione indipendente ON-OFF.
Doppia accensione indipendente DALI (gestita dalla console DALI).
On request:
Independent ON-OFF double switching.
Independent DALI double switching (controlled through DALI console).

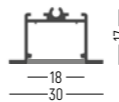

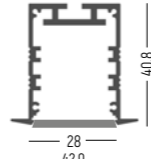
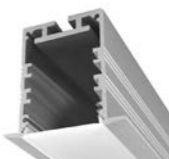
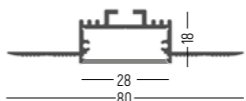
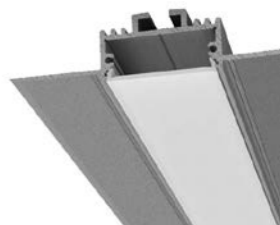
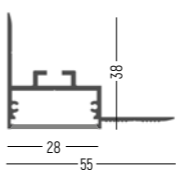
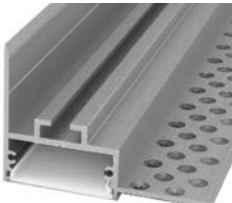
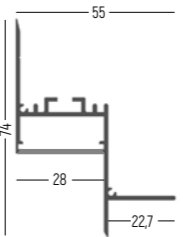
A richiesta:
Doppia accensione indipendente ON-OFF
On request:
Independent ON-OFF double switching

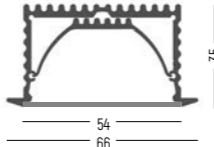
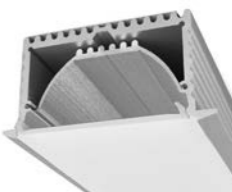
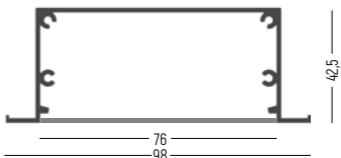
LIGHT CUT SISTEMI LINEARI MODULARI (SISTEMA FINITO)
MODULAR LINEAR SYSTEM (FINISHED SYSTEM)



CODICE CODE	DESCRIZIONE DESCRIPTION	FASCIO BEAM	COLORE FINISH		
620-100-LBC/LBN-OP	LIGHT CUT 20 foro 22x1014mm - L.1010mm LBC 14.4W 1600Lm 24Vdc - Opale/opal	120°	BR	 foro 22 x L + 4mm	LIGHT CUT 20 
620-200-LBC/LBN-OP	LIGHT CUT 20 foro 22x2014mm - L.2010mm LBC 28.8W 3200Lm 24Vdc - Opale/opal				
620-300-LBC/LBN-OP	LIGHT CUT 20 foro 22x3014mm - L.3010mm LBC 43.2W 4800Lm 24Vdc - Opale/opal				
620-9090-LBC/LBN-OP	LIGHT CUT 20 ANGOLARE 130x130mm 3W 300Lm 24Vdc - Opale/opal				
630-100-LBC/LBN-OP	LIGHT CUT 30 C.BATTUTA foro 32x1014mm - L.1010mm 22W 3000Lm 24Vdc - Opale/opal	120°	BR	 foro 32 x L + 4mm	LIGHT CUT 30 BATTUTA FRAME 
630-200-LBC/LBN-OP	LIGHT CUT 30 C.BATTUTA foro 32x2014mm - L.2010mm 44W 6000Lm 24Vdc - Opale/opal				
630-300-LBC/LBN-OP	LIGHT CUT 30 C.BATTUTA foro 32x3014mm - L.3010mm 66W 9000Lm 24Vdc - Opale/opal				
630-9090-LBC/LBN-OP	LIGHT CUT 30 ANGOLARE 182x182mm 6,6W 900Lm 24Vdc - Opale/opal				
631-100-LBC/LBN-OP	LIGHT CUT 30SC S.CORNICE foro 32x1014mm - L.1010mm 22W 3000Lm 24Vdc - Opale/opal	120°	BR	 foro 32 x L + 4mm	LIGHT CUT 30SC SENZA CORNICE TRIMLESS 
631-200-LBC/LBN-OP	LIGHT CUT 30SC S.CORNICE foro 32x2014mm - L.2010mm 44W 6000Lm 24Vdc - Opale/opal				
631-300-LBC/LBN-OP	LIGHT CUT 30SC S.CORNICE foro 32x3014mm - L.3010mm 66W 9000Lm 24Vdc - Opale/opal				
631-9090-LBC/LBN-OP	LIGHT CUT 30SC ANGOLARE 200x200 6,6W 24Vdc - Opale/opal				
632-100-LBC/LBN-OP	LIGHT CUT 30ASC ANG.S.CORNICE foro 32x1016mm - L.1010mm 22W 3000Lm 24V - Opale/opal	120°	BR	 foro 32 x L + 6mm	LIGHT CUT 30ASC ANGOLARE SENZA CORNICE CORNER TRIMLESS 
632-200-LBC/LBN-OP	LIGHT CUT 30ASC ANG.S.CORNICE foro 32x2016mm - L.2010mm 44W 6000Lm 24V - Opale/opal				
632-300-LBC/LBN-OP	LIGHT CUT 30ASC ANG.S.CORNICE foro 32x3016mm - L.3010mm 66W 9000Lm 24V - Opale/opal				
632-9090-LBC/LBN-OP	LIGHT CUT 30ASC ANGOLARE 175x175mm 6,6W 900Lm 24Vdc - Opale/opal				
633-100-LBC/LBN-OP	LIGHT CUT 30AR ANG.L RETR. foro 32x1016mm - L.1010mm LBC 22W 24V - Opale/opal	120°	BR	 foro 32 x L + 6mm	LIGHT CUT 30AR ANGOLARE LUCE RETROCESSA CORNER RECESSED LIGHT 
633-200-LBC/LBN-OP	LIGHT CUT 30AR ANG.L RETR. foro 32x2016mm - L.2010mm LBC 44W 24V - Opale/opal				
633-300-LBC/LBN-OP	LIGHT CUT 30AR ANG.L RETR. foro 32x3016mm - L.3010mm LBC 66W 24V - Opale/opal				
633-9090-LBC/LBN-OP	LIGHT CUT 30AR ANGOLARE 175x175mm 6,6W 900Lm 24Vdc - Opale/opal				
655-100-LBC/LBN-OP	LIGHT CUT 55 foro 55x1016mm - L.1010mm LBC 44W 24Vdc - Opale/opal	120°	BR	 foro 55 x L + 6mm	LIGHT CUT 55 
655-200-LBC/LBN-OP	LIGHT CUT 55 foro 55x2016mm - L.2010mm LBC 88W 24Vdc - Opale/opal				
655-300-LBC/LBN-OP	LIGHT CUT 55 foro 55x3016mm - L.3010mm LBC 132W 24Vdc - Opale/opal				
655-9090-LBC/LBN-OP	LIGHT CUT 55 ANGOLARE 198x198mm 13,2W 1800Lm 24Vdc - Opale/opal				
675-100-LBC/LBN-OP	LIGHT CUT 75 foro 88x1017mm - L.1010mm LBC 60W 6100Lm 24Vdc - Opale/opal	120°	BR	 foro 88 x L + 7mm	LIGHT CUT 75 
675-200-LBC/LBN-OP	LIGHT CUT 75 foro 88x2017mm - L.2010mm LBC 120W 12200Lm 24Vdc - Opale/opal				
675-300-LBC/LBN-OP	LIGHT CUT 75 foro 88x3017mm - L.3010mm LBC 180W 18300Lm 24Vdc - Opale/opal				
675-9090-LBC/LBN-OP	LIGHT CUT 75 ANGOLARE 158x158mm 15W 1260Lm 24Vdc - Opale/opal				

LIGHT CUT SISTEMI LINEARI MODULARI (SISTEMA COMPONIBILE)

MODULAR LINEAR SYSTEM (MODULAR SYSTEM)

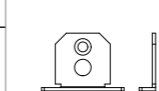
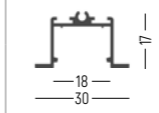

CODICE CODE	DESCRIZIONE DESCRIPTION	FASCIO BEAM	COLORE FINISH
LIGHT CUT 20 COMPONIBILE - MODULAR			
980085	Kit Estruso alluminio - Aluminium extruded Kit - 20mm 2m - foro 22xL+4mm	-	BR
980086	Kit Estruso alluminio - Aluminium extruded Kit - 20mm 3m - foro 22xL+4mm	-	BR
980087	Kit schermo piano policarbonato opal - Flat diffuser polycarbonate opal - 20mm 2m	-	-
980088	Kit schermo piano policarbonato opal - Flat diffuser opale polycarbonate - 20mm 3m	-	-
6011	Kit testate di chiusura - Closing heads Kit	-	BR
980117	Kit molle per ancoraggio - Springs for installation kit	-	-
646165-LBC/LBN	Strip led 14,4W/m 24Vdc - L. 5m	120°	-
646165-LBC/LBN-25MT	Strip led 14,4W/m 24Vdc- L. 25m	120°	-



LIGHT CUT 20 COMPONIBILE



foro 22 x L + 4mm

LIGHT CUT 30 COMPONIBILE - MODULAR			
980089	Kit Estruso alluminio - Aluminium extruded Kit - 30mm 2m - foro 32xL+4mm	-	BR
980090	Kit Estruso alluminio - Aluminium extruded Kit - 30mm 3m - foro 32xL+4mm	-	BR
980105	Dissipatore - Heat-sink 2m	-	BR
980106	Dissipatore - Heat-sink 3m	-	BR
980101	Kit schermo piano policarbonato prismatico - Flat diffuser prismatic polycarbonate - 30mm 2m	-	-
980102	Kit schermo piano policarbonato prismatico - Flat diffuser prismatic polycarbonate - 30mm 3m	-	-
980103	Kit schermo piano policarbonato opal - Flat diffuser polycarbonate opal - 30mm 2m	-	-
980104	Kit schermo piano policarbonato opal - Flat diffuser opale polycarbonate - 30mm 3m	-	-
980074	Kit testate di chiusura - Closing heads Kit	-	BR
980073	Kit molle per ancoraggio - Springs for installation kit	-	-
980075	Giunzione lineare - Linear conjunction	-	-
980076	Giunzione angolare - Angular conjunction	-	-
980078	Giunzione verticale - Vertical conjunction	-	-
646165-LBC/LBN	Strip led 14,4W/m 24Vdc - L. 5m	120°	-
646165-LBC/LBN-25MT	Strip led 14,4W/m 24Vdc- L. 25m	120°	-

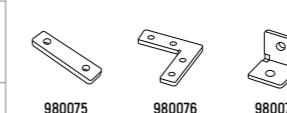
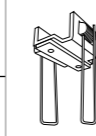
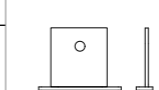
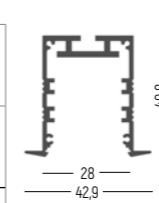

LIGHT CUT 30 COMPONIBILE

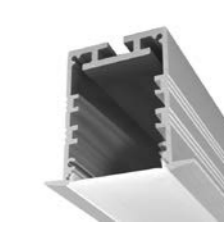

foro 32 x L + 4mm

LIGHT CUT SISTEMI LINEARI MODULARI (SISTEMA COMPONENTE)

MODULAR LINEAR SYSTEM (MODULAR SYSTEM)



CODICE CODE	DESCRIZIONE DESCRIPTION	FASCIO BEAM	COLORE FINISH
LIGHT CUT 30SC COMPONENTE SENZA CORNICE - TRIMLESS MODULAR			
980091	Kit Estruso alluminio - Aluminium extruded Kit - 30mm 2m - foro 32xL+4mm	-	BR
980093	Kit Estruso alluminio - Aluminium extruded Kit - 30mm 3m - foro 32xL+4mm	-	BR
980101	Kit schermo piano policarbonato prismatico - Flat diffuser prismatic polycarbonate - 30mm 2m	-	-
980102	Kit schermo piano policarbonato prismatico - Flat diffuser prismatic polycarbonate - 30mm 3m	-	-
980103	Kit schermo piano policarbonato opal - Flat diffuser polycarbonate opal - 30mm 2m	-	-
980104	Kit schermo piano policarbonato opal - Flat diffuser polycarbonate opal - 30mm 3m	-	-
980082	Kit testate di chiusura - Closing heads Kit	-	BR
980075	Giunzione lineare - Linear conjunction	-	-
980076	Giunzione angolare - Angular conjunction	-	-
980078	Giunzione verticale - Vertical conjunction	-	-
646165-LBC/LBN	Strip led 14,4W/m 24Vdc - L. 5m	120°	-
646165-LBC/LBN-25MT	Strip led 14,4W/m 24Vdc - L. 25m	120°	-

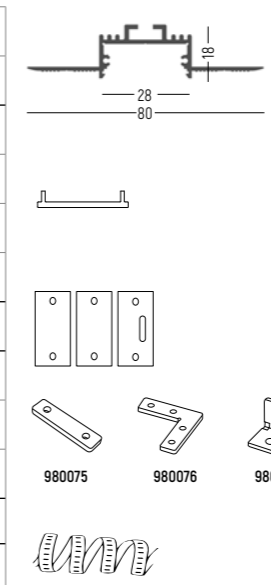

LIGHT CUT 30SC COMPONENTE

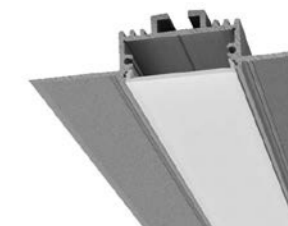

foro 32 x L + 4mm

LIGHT CUT 30ASC COMPONENTE ANGOLARE SENZA CORNICE - TRIMLESS MODULAR CORNER			
980097	Kit Estruso alluminio - Aluminium extruded Kit - 30mm 2m - foro 32xL+6mm	-	BR
980099	Kit Estruso alluminio - Aluminium extruded Kit - 30mm 3m - foro 32xL+6mm	-	BR
980101	Kit schermo piano policarbonato prismatico - Flat diffuser prismatic polycarbonate - 30mm 2m	-	-
980102	Kit schermo piano policarbonato prismatico - Flat diffuser prismatic polycarbonate - 30mm 3m	-	-
980103	Kit schermo piano policarbonato opal - Flat diffuser polycarbonate opal - 30mm 2m	-	-
980104	Kit schermo piano policarbonato opal - Flat diffuser polycarbonate opal - 30mm 3m	-	-
980077	Kit testate di chiusura - Closing heads Kit	-	BR
980075	Giunzione lineare - Linear conjunction	-	-
980076	Giunzione angolare - Angular conjunction	-	-
980078	Giunzione verticale - Vertical conjunction	-	-
646195-LBC/LBN	Strip led 22W/m 24Vdc - L. 5m	120°	-
646195-LBC/LBN-25MT	Strip led 22W/m 24Vdc - L. 25m	120°	-

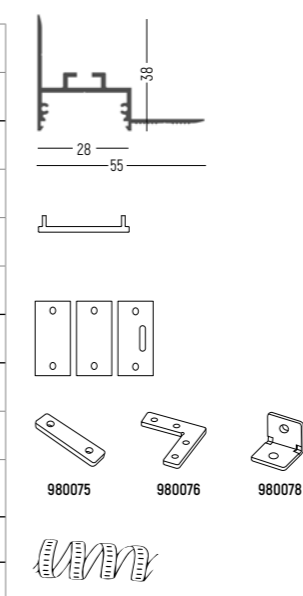

LIGHT CUT 30ASC COMPONENTE

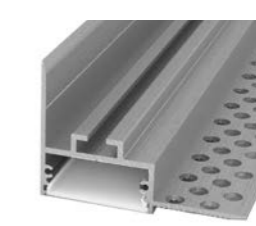

foro 32 x L + 6mm

LIGHT CUT 30AR COMPONENTE ANGOLARE LUCE RETROCESSA - RECESSED LIGHT TRIMLESS MODULAR CORNER			
980095	Kit Estruso alluminio - Aluminium extruded Kit - 30mm 2m - foro 32xL+6mm	-	BR
980096	Kit Estruso alluminio - Aluminium extruded Kit - 30mm 3m - foro 32xL+6mm	-	BR
980101	Kit schermo piano policarbonato prismatico - Flat diffuser prismatic polycarbonate - 30mm 2m	-	-
980102	Kit schermo piano policarbonato prismatico - Flat diffuser prismatic polycarbonate - 30mm 3m	-	-
980103	Kit schermo piano policarbonato opal - Flat diffuser polycarbonate opal - 30mm 2m	-	-
980104	Kit schermo piano policarbonato opal - Flat diffuser polycarbonate opal - 30mm 3m	-	-
980083	Kit testate di chiusura - Closing heads Kit	-	BR
980075	Giunzione lineare - Linear conjunction	-	-
980076	Giunzione angolare - Angular conjunction	-	-
980078	Giunzione verticale - Vertical conjunction	-	-
646195-LBC/LBN	Strip led 22W/m 24Vdc - L. 5m	120°	-
646195-LBC/LBN-25MT	Strip led 22W/m 24Vdc - L. 25m	120°	-

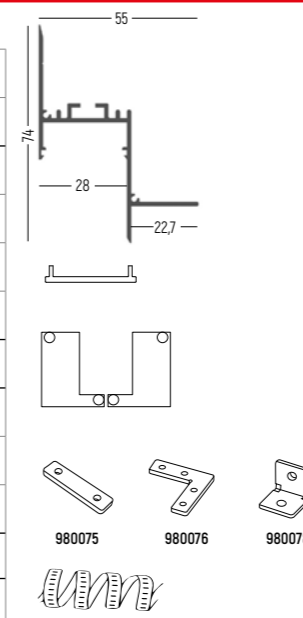

LIGHT CUT 30AR COMPONENTE



foro 32 x L + 6mm

LIGHT CUT SISTEMI LINEARI MODULARI (SISTEMA COMPONENTE)

MODULAR LINEAR SYSTEM (MODULAR SYSTEM)



CODICE CODE	DESCRIZIONE DESCRIPTION	FASCIO BEAM	COLORE FINISH
LIGHT CUT 55 COMPONENTE - MODULAR			
980107	Kit Estruso alluminio - Aluminium extruded Kit - 50mm 2m - foro 55xL+6mm	-	BR
980108	Kit Estruso alluminio - Aluminium extruded Kit - 50mm 2m - foro 55xL+6mm	-	BR
980109	Dissipatore - Heat-sink - 2m	-	BR
980110	Dissipatore - Heat-sink - 3m	-	BR
980111	Kit schermo piano policarbonato prismatico - Flat diffuser prismatic polycarbonate - 50mm 2m	-	-
980112	Kit schermo piano policarbonato prismatico - Flat diffuser prismatic polycarbonate - 50mm 3m	-	-
980113	Kit schermo piano policarbonato opal - Flat diffuser polycarbonate opal - 50mm 2m	-	-
980114	Kit schermo piano policarbonato opal - Flat diffuser polycarbonate opal - 50mm 3m	-	-
980079	Kit testate di chiusura - Closing heads Kit	-	BR
980080	Staffa con molla - Bracket with spring	-	-
980081	Staffa per cartongesso - Spring kit for plasterboard	-	-
646195-LBC/LBN	Strip led 22W/m 24Vdc - L. 5m	120°	-
646195-LBC/LBN-25MT	Strip led 22W/m 24Vdc - L. 25m	120°	-

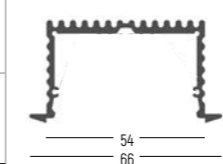

LIGHT CUT 55 COMPONENTE

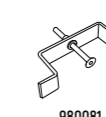
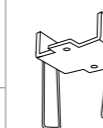
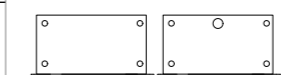
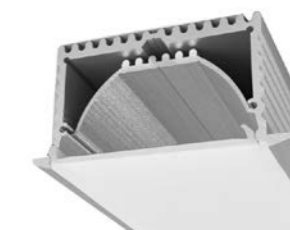

foro 55 x L + 6mm

LIGHT CUT 75 COMPONENTE - MODULAR

980115	Kit Estruso alluminio - Aluminium extruded Kit - 75mm 2m - foro 88xL+7mm	-	BR
980116	Kit Estruso alluminio - Aluminium extruded Kit - 75mm 3m - foro 88xL+7mm	-	BR
699815	Kit schermo piano policarbonato opal - Flat diffuser polycarbonate opal - 50mm 2m	-	-
699816	Kit schermo piano policarbonato opal - Flat diffuser polycarbonate opal - 50mm 3m	-	-
3443	Kit testate di chiusura - Closing heads Kit	-	BR
3444	Giunzione lineare - Linear conjunction	-	-
980084	Staffa per cartongesso - Spring for plasterboard	-	-
646752-LBC/LBN	Strip led rigida - Rigid LED strip 30W/m 24Vdc - L. 0,50m (confezione minima 10 pz - minimum package 10 pcs)	120°	-

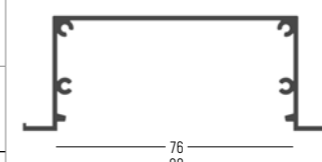

LIGHT CUT 75 COMPONENTE

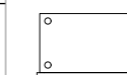

foro 88 x L + 7mm

LINEA SISTEMI LINEARI MODULARI - LINEAR MODULAR SYSTEM



CODICE CODE	DESCRIZIONE DESCRIPTION	FASCIO BEAM	COLORE FINISH	
4442	LINEA Canalina elettrificata - Electrified cable tray - L.1415 mm	-	-	
4444	LINEA Canalina elettrificata - Electrified cable tray - L.2820 mm	-	-	
4433-LBC/LBN	LINEA L.1415mm 40W 5800Lm 500mA IP40 - STANDARD	STANDARD	BR	<p>OTTICA FASCIO STANDARD STANDARD BEAM OPTIC OTTICA FASCIO DIFFUSO DIFFUSED BEAM OPTIC OTTICA FASCIO DOPPIO ASIMMETRICO DOUBLE ASYMMETRIC BEAM OPTIC OTTICA FASCIO ASIMMETRICO ASYMMETRIC BEAM OPTIC</p>
4434-LBC/LBN	LINEA L.1415mm 40W 5800Lm 500mA IP40 - DIFFUSO/DIFFUSED	DIFFUSO	BR	
4435-LBC/LBN	LINEA L.1415mm 40W 5800Lm 500mA IP40 - DOPPIO ASIMMETRICO/DOUBLE ASYMMETRIC	DOPPIO ASIM	BR	
4430-LBC/LBN	LINEA L.1415mm 40W 5800Lm 500mA IP40 - ASIMMETRICO/ASYMMETRIC	ASIMMETRICO	BR	
4439-LBC/LBN	LINEA L.2820mm 76,5W 12000Lm 500mA IP40 - STANDARD	STANDARD	BR	<p>IP 40 </p> <p>a richiesta on request</p>
4440-LBC/LBN	LINEA L.2820mm 76,5W 12000Lm 500mA IP40 - DIFFUSO/DIFFUSED	DIFFUSO	BR	
4441-LBC/LBN	LINEA L.2820mm 76,5W 12000Lm 500mA IP40 - DOPPIO ASIMMETRICO/DOUBLE ASYMMETRIC	DOPPIO ASIM	BR	
4432-LBC/LBN	LINEA L.2820mm 76,5W 12000Lm 500mA IP40 - ASIMMETRICO/ASYMMETRIC	ASIMMETRICO	BR	
6017	Kit gancio sospensione standard - Standard suspension hook kit	-	BR	
6018	Kit gancio sospensione controsoffitti - False ceiling suspension hook kit	-	BR	
6019	Kit gancio sospensione aggancio catena - False ceiling suspension hook kit	-	BR	
6020	Congiunzione kit 6 pz - Junction kit 6 pcs	-	-	
6022	Kit alimentazione testata canalina elettrica - Head power-supply	-	-	
6023	Kit alimentazione intermedia canalina elettrificata - DORSALE A 7 POLI Intermediate power supply - 7 POLES LINEAR CONNECTOR	-	-	
6028	Testata di chiusura - End cap	-	BR	
6029	Linea modulo emergenza 1 ora - Emergency module 1H	-	-	
6029-3	Linea modulo emergenza 3 ore - Emergency module 3H	-	-	



20

DOT 20

foro ø 19mm - 1,2W - 95Lm



30

DOT 30

foro ø 25mm - 4,2W - 550Lm



40

DOT 45

foro ø 40mm - 4,2W - 550Lm



50

SHELF

foro ø 58mm - 3,5W - 285Lm



60

DOT 60

foro ø 61mm - 12,9W - 1300Lm



70

80

BBTT COIN

foro ø 76mm - 12,9W - 1300Lm



DOT 80

foro ø 85mm - 12,9W - 1400Lm



90

BBTT BLOCK

foro ø 82mm - 12W - 1200Lm







DOT 90

foro ø 92mm - 24W - 3400Lm

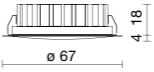

INCASSI SPOT - RECESSED SPOT



CODICE CODE	DESCRIZIONE DESCRIPTION	FASCIO BEAM	COLORE FINISH	
0021COB	SHELF TONDO/ROUND Foro ø 58mm 3,5W 285Lm 350mA IP40	45°	BI	   SHELF
0022COB			NE	
0023COB			CR	
0024COB			ORO	
0025COB			CM	
0021COB-Q	SHELF QUADRO/SQUARE Foro ø 58mm 3,5W 285Lm 350mA IP40	45°	BI	 foro 58mm
0022COB-Q			NE	
0023COB-Q			CR	
0024COB-Q			ORO	
0025COB-Q			CM	
0021COB-54	SHELF TONDO/ROUND Foro ø 58mm 3,5W 285Lm - IP54	45°	BI	
0022COB-54			NE	
0023COB-54			CR	
120- CR	ACCESSORI - ACCESSORIES Ghiera per applicazione a plafone - Ring for ceiling application	-	BI - CR	
645732	Driver consigliato - Recommended driver ON-OFF IP20 2,5/42W - 150/1050mA	-	-	

IP40

INCASSI SPOT - RECESSED SPOT



CODICE CODE	DESCRIZIONE DESCRIPTION	FASCIO BEAM	COLORE FINISH		
2815C-LBC/LBN-15/24/40	BBTT COIN Foro ø 76mm 12,9W 1300Lm 350mA - FISSO/FIX	15 - 24 - 40°	BI		<p>BBTT COIN</p> <p>FISSO FIX</p>
2816C-LBC/LBN-15/24/40			NE		
2817C-LBC/LBN-15/24/40			CR		
2818C-LBC/LBN-15/24/40			ORO		
2825C-LBC/LBN-25/40	BBTT COIN Foro ø 82mm 12,9W 1300Lm 350mA - SEMIORIENTABILE/SEMIADJUSTABLE	15 - 24 - 40°	BI		<p>SEMIORIENTABILE SEMIADJUSTABLE</p>
2826C-LBC/LBN-25/40			NE		
2827C-LBC/LBN-25/40			CR		
2828C-LBC/LBN-25/40			ORO		
645732	Driver consigliato - Recommended driver ON-OFF IP20 2,5/42W - 150/1050mA	-	-		
2825-JLBC/JLBN-25/40	BBTT BLOCK Foro ø 82mm 12W 1200Lm 350mA	25 - 40°	BI		<p>BBTT BLOCK</p> <p>SEMIORIENTABILE SEMIADJUSTABLE</p>
2826-JLBC/JLBN-25/40			NE		
645732	Driver consigliato - Recommended driver ON-OFF IP20 2,5/42W - 150/1050mA	-	-		<p>a richiesta - on request</p>

INCASSI SPOT - RECESSED SPOT



CODICE CODE	DESCRIZIONE DESCRIPTION	FASCIO BEAM	COLORE FINISH				
1224-LBC/LBN	DOT 20 TONDO/ROUND Foro ø 19mm 1,2W 95Lm 350mA	10°	BI				
1225-LBC/LBN			NE				
1226-LBC/LBN	DOT 20 TONDO/ROUND Foro ø 19mm 1,2W 95Lm 350mA	25°	BI				
1227-LBC/LBN			NE				
1224-Q-LBC/LBN	DOT 20 QUADRO/SQUARE Foro ø 19mm 1,2W 95Lm 350mA	10°	BI				
1225-Q-LBC/LBN			NE				
1226-Q-LBC/LBN	DOT 20 QUADRO/SQUARE Foro ø 19mm 1,2W 95Lm 350mA	25°	BI				
1227-Q-LBC/LBN			NE				
645732	Driver consigliato - Recommended driver ON-OFF IP20 2,5/42W - 150/1050mA	-	-		IP 20		
1220-LBC/LBN	DOT 30 TONDO/ROUND Foro ø 25mm 1,2W 95Lm 350mA	15°	BI				
1221-LBC/LBN			NE				
1222-LBC/LBN	DOT 30 TONDO/ROUND Foro ø 25mm 1,2W 95Lm 350mA	25°	BI				
1223-LBC/LBN			NE				
1220-Q-LBC/LBN	DOT 30 QUADRO/SQUARE Foro ø 25mm 1,2W 95Lm 350mA	15°	BI				
1221-Q-LBC/LBN			NE				
1222-Q-LBC/LBN	DOT 30 QUADRO/SQUARE Foro ø 25mm 1,2W 95Lm 350mA	25°	BI				
1223-Q-LBC/LBN			NE				
645732	Driver consigliato - Recommended driver ON-OFF IP20 2,5/42W - 150/1050mA	-	-		IP 20 a richiesta on request		
1228-LBC/LBN	DOT 45 TONDO/ROUND Foro ø 30mm 4,2W 550Lm 350mA	10°	BI				
1229-LBC/LBN			NE				
1230-LBC/LBN	DOT 45 TONDO/ROUND Foro ø 30mm 4,2W 550Lm 350mA	45°	BI				
1231-LBC/LBN			NE				
645906	Driver consigliato - Recommended driver ON-OFF 8W IP20 350mA	-	-				IP 20
2891C-LBC/LBN-15/24/40	DOT 60 Foro ø 61mm 12,9W 1300Lm 350mA	15 - 24 - 40°	BR				
2892C-LBC/LBN-15/24/40			NE				
2893C-LBC/LBN-15/24/40			GR				
645732	Driver consigliato - Recommended driver ON-OFF IP20 2,5/42W - 150/1050mA	-	-		IP 20 IP 40 a richiesta on request		
2819C-LBC/LBN-15/24/40	DOT 80 Foro ø 85mm 12,9W 1300Lm 350mA - FISSO/FIX	15 - 24 - 40°	BR				
2820C-LBC/LBN-15/24/40			NE				
2821C-LBC/LBN-15/24/40			GR				
645732	Driver consigliato - Recommended driver ON-OFF IP20 2,5/42W - 150/1050mA	-	-				IP 20 IP 40 a richiesta on request RGB
2865-LBC/LBN	DOT 90 Foro ø 92mm 24W 3400Lm 700mA	90°	BI				
2866-LBC/LBN			NE				
644936	Driver consigliato - Recommended driver ON-OFF 25W 700mA	-	-		IP 20 IP 40 a richiesta - on request		

DOWNLIGHTS

INCASSI PLAFONE DA INTERNO - RECESSED CEILING DOWNLIGHT



100

SWING 10
 Foro ø 95mm - 17W - 2400Lm

SWING 10 UGR
 foro ø 102mm - 14W - 1100Lm

SENZA CORNICE - TRIMLESS

NET SC XS
 foro ø 110mm - 12,9W - 1500Lm

130

NET 13 BLOCK
 foro ø 129mm - 36W - 4000Lm

IP54

SWING 13
 foro ø 120mm - 37/52W - 3500/5800Lm

SWING 13 UGR
 Foro ø 122mm - 20W - 2000Lm

150



STEP 15
 foro ø 156mm - 18-27W - 2300Lm

NET 15 BLOCK
 foro ø 156mm - 27-41W - 4200Lm

SWING 15
 foro ø 156mm - 24-47W - 2800/4900Lm

VERSIONI/VERSION
STANDARD
FLAT
ASIMMETRICO/ASYMETRIC
ORIENTABILE/ADJUSTABLE

200

STEP 18
 foro ø 205mm - 18-27W - 2300Lm

NET 18 BLOCK
 Foro ø 205mm - 24-37W - 4500Lm

NET SC XL
 foro ø 200mm - 15W - 1300Lm

290 - 770

BIG INCASSO
 290 - 380 - 570 - 770

<p>ANELLO DI COMPENSAZIONE COMPENSATION RING</p>	
codice code 116	FORO ESISTENTE EXISTING HOLE max ø 140 m IN ø 75 mm OUT ø 150 mm
codice code 117	FORO ESISTENTE EXISTING HOLE max ø 150 m IN ø 80 mm OUT ø 160 mm
codice code 122	FORO ESISTENTE EXISTING HOLE max ø 190 m IN ø 156 mm OUT ø 210 mm
codice code 125	FORO ESISTENTE EXISTING HOLE max ø 235 m IN ø 205 mm OUT ø 255 mm
codice code 126	FORO ESISTENTE EXISTING HOLE max ø 250 m IN ø 205 mm OUT ø 270 mm

DOWNLIGHTS



CODICE CODE	DESCRIZIONE DESCRIPTION	FASCIO BEAM	COLORE FINISH			
57420-LBC/LBN	STEP 15 Foro ø 156mm 21W 2000Lm 220-2240V	90°	BR			
57421-LBC/LBN	STEP 15 Foro ø 156mm 31W 3000Lm 220-2240V	90°	BR			foro 156mm
57437-LBC/LBN	STEP 18 Foro ø 205mm 21W 2000Lm 220-2240V	90°	BR			
57438-LBC/LBN	STEP 18 Foro ø 205mm 31W 3000Lm 220-2240V	90°	BR			foro 205mm
57437-LBC/LBN-UGR	STEP 18 UGR Foro ø 205mm 21W 2000Lm 220-2240V UGR<19	90°	BR			
57438-LBC/LBN-UGR	STEP 18 UGR Foro ø 205mm 31W 3000Lm 220-2240V UGR<19	90°	BR			foro 205mm
57438-2G	STEP 18 2G Foro ø 200mm 45.4W 3540Lm 220-240V - 3000/4000/6000K - IP44	110°	BR			
125	ACCESSORI - ACCESSORIES Anello di compensazione - Compensation ring d=205 mm/D=255 mm	-	-			
126	Anello di compensazione - Compensation ring d=205 mm/D=270 mm	-	-			ANELLO DI COMPENSAZIONE COMPENSATION RING
57558-LBC/LBN-12/25/40	NET 13 BLOCK Foro ø 125mm 36W 3900Lm 900mA	12 - 25 - 40°	BR			
57559-LBC/LBN-12/25/40	NET 13 BLOCK Foro ø 125mm 36W 3900Lm 900mA		GA			foro 129mm
57564-LBC/LBI	NET 15 BLOCK Foro ø 156mm 27W 3000Lm 700mA	40°	BR			
57565-LBC/LBI			GA			
57560-LBC/LBI	NET 15 BLOCK Foro ø 156mm 27W 3000Lm 700mA	90°	BR			
57561-LBC/LBI			GA			
57566-LBC/LBI	NET 15 BLOCK Foro ø 156mm 41W 4200Lm 1050mA	40°	BR			
57567-LBC/LBI			GA			
57562-LBC/LBI	NET 15 BLOCK Foro ø 156mm 41W 4200Lm 1050mA	90°	BR	foro 156mm		
57563-LBC/LBI			GA			
57570-LBC/LBI	NET 18 BLOCK Foro ø 205mm 27W 3000Lm 1050mA	90°	BR			
57571-LBC/LBI			GA			
57572-LBC/LBI	NET 18 BLOCK Foro ø 205mm 41W 4300Lm 1050mA	90°	BR			
57573-LBC/LBI			GA			
57575-LBC/LBI	NET 18 BLOCK PLUS Foro ø 205mm 47W 4800Lm 1200mA	90°	BR			foro 205mm
57576-LBC/LBI			GA			

a richiesta on request

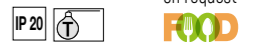

DOWNLIGHTS



CODICE CODE	DESCRIZIONE DESCRIPTION	FASCIO BEAM	COLORE FINISH						
KT2880/81-LBC/LBN-OF	SWING 10 foro ø 95mm - Kit 20W 2000Lm 500mA + DRIVER 645732 ON-OFF	25 - 40°	BR		<p>SWING 10 ORIENTABILE - ADJUSTABLE</p>				
KT2880/81-LBC/LBN-PH	SWING 10 foro ø 95mm - Kit 20W 2000Lm 500mA + DRIVER 644757 DIM 1-10V/PUSH	25 - 40°	BR				<p>SWING 10 ORIENTABILE - ADJUSTABLE</p>		
KT2880/81-LBC/LBN-DA	SWING 10 foro ø 95mm - Kit 20W 2000Lm 500mA + DRIVER 644757DA DALI	25 - 40°	BR						<p>SWING 13 ORIENTABILE - ADJUSTABLE</p>
KT2885/86/87-LBC/LBN-OF	SWING 13 foro ø 120mm - Kit 37W 900mA 3500Lm + DRIVER 646168-I ON-OFF	15 - 30 - 60°	BR		<p>SWING 13 ORIENTABILE - ADJUSTABLE</p>				
KT2885/86/87-LBC/LBN-DA	SWING 13 foro ø 120mm - Kit 37W 900mA 3500Lm + DRIVER 645384-DA DALI	15 - 30 - 60°	BR				<p>SWING 13 LOW ORIENTABILE - ADJUSTABLE a richiesta - on request</p>		
KT2890-LBC-OF	SWING 13LOW foro ø 120mm - Kit 52W 5800Lm 1400mA + DRIVER 646455 ON-OFF	15 - 30 - 60°	BR		<p>SWING 13 LOW ORIENTABILE - ADJUSTABLE a richiesta - on request</p>				
KT2890-LBC-DA	SWING 13LOW foro ø 120mm - Kit 52W 5800Lm 1400mA + DRIVER 645845 DALI	15 - 30 - 60°	BR				<p>SWING 10 UGR ORIENTABILE - ADJUSTABLE</p>		
67935-LBC/LBN	SWING 10 UGR foro ø 102mm 14W 1100Lm 350mA	25°	BR		<p>SWING 10 UGR ORIENTABILE - ADJUSTABLE</p>				
67936-LBC/LBN			NE						
67937-LBC/LBN			GR						
67938-LBC/LBN	SWING 10 UGR QUADRO foro ø 102mm 14W 1100Lm 350mA	25°	BR						<p>SWING 10 UGR ORIENTABILE - ADJUSTABLE</p>
67939-LBC/LBN			NE						
67940-LBC/LBN			GR						
645732	Driver consigliato - Recommended driver ON-OFF IP20 2,5/42W - 150/1050mA	-	-		<p>SWING 13 UGR ORIENTABILE - ADJUSTABLE</p>				
67942-LBC/LBN	SWING 13 UGR foro ø 122mm 20W 2000Lm 800mA	25°	BR				<p>SWING 13 UGR ORIENTABILE - ADJUSTABLE</p>		
67943-LBC/LBN			NE						
67944-LBC/LBN			GR						
67945-LBC/LBN	SWING 13 UGR QUADRO foro ø 122mm 20W 2000Lm 800mA	25°	BR						<p>SWING 13 UGR ORIENTABILE - ADJUSTABLE</p>
67946-LBC/LBN			NE						
67947-LBC/LBN			GR						
645086	Driver consigliato - Recommended driver ON-OFF 20W IP20 500mA	-	-		<p>SWING 15 ORIENTABILE ORIENTABILE - ADJUSTABLE</p>				
57554-LBC/LBI-30/60	SWING 15 ORIENTABILE foro ø 156mm 27W 2800Lm 700mA	30 - 60°	BR				<p>SWING 15 ORIENTABILE ORIENTABILE - ADJUSTABLE</p>		
57555-LBC/LBI-30/60			GA						
57556-LBC/LBI-30/60	SWING 15 ORIENTABILE foro ø 156mm 41W 4400Lm 1050mA	30 - 60°	BR						<p>SWING 15 ORIENTABILE ORIENTABILE - ADJUSTABLE</p>
57557-LBC/LBI-30/60			GA						
57585-LBC/LBI-30/60	SWING 15 ORIENTABILE foro ø 156mm 47W 4900Lm 1200mA	30 - 60°	BR						
57586-LBC/LBI-30/60			GA						



DOWNLIGHTS



CODICE CODE	DESCRIZIONE DESCRIPTION	FASCIO BEAM	COLORE FINISH						
57550-LBC/LBI/-60	SWING 15 foro ø 156mm 27W 3300Lm 700mA	30 - 60°	BR						
57551-LBC/LBI/-60			GA						
57552-LBC/LBI/-60	SWING 15 foro ø 156mm 41W 4700Lm 1050mA	30 - 60°	BR						
57553-LBC/LBI/-60			GA						
57580-LBC/LBI-30/60	SWING 15 PLUS foro ø 156mm 47W 4900Lm 1200mA	30 - 60°	BR						
57581-LBC/LBI-30/60			GA						
57550AS-LBC/LBI	SWING 15 ASYMMETRIC foro ø 156mm 27W 2700Lm 700mA	ASIM	BR						
57551AS-LBC/LBI			GA						
57552AS-LBC/LBI	SWING 15 ASYMMETRIC foro ø 156mm 41W 3700Lm 1050mA	ASIM	BR						
57553AS-LBC/LBI			GA						
57580AS-LBC/LBI	SWING 15 ASYMMETRIC PLUS foro ø 156mm 47W 4000Lm 1200mA	ASIM	BR						
57581AS-LBC/LBI			GA						
57550R-LBC/LBI/-60	SWING 15 FLAT foro ø 156mm 27W 3300Lm 700mA	30 - 60°	BR						
57551R-LBC/LBI/-60			GA						
57552R-LBC/LBI/-60	SWING 15 FLAT foro ø 156mm 41W 4500Lm 1050mA	30 - 60°	BR						
57553R-LBC/LBI/-60			GA						
57580R-LBC/LBI-30/60	SWING 15 FLAT PLUS foro ø 156mm 47W 4900Lm 1200mA	30 - 60°	BR						
57581R-LBC/LBI-30/60			GA						
5695-MLBC/LBN-25/40	NET SC XS Foro ø 110mm 12,9W 1400Lm 350mA	25 - 40°	BR						NET SC XS SENZA CORNICE - TRIMLESS
5798-LBC/LBN	NET SC XL Foro ø 200mm 15W 1350Lm 700mA	25 - 40°	BR						NET SC XL SENZA CORNICE - TRIMLESS
645833	Driver consigliato - Recommended driver DIM F.T. 15W IP20 230-240V/500mA	-	-						
5508-LBC/LBN	BIG INCASSO 290 Foro ø 295mm 16W 1450Lm 500mA	-	BR		BIG INCASSO 290 - 380 - 570 - 770 SENZA CORNICE - TRIMLESS 				
5516-LBC/LBN	BIG INCASSO 380 Foro ø 385mm 21W 2100Lm 700mA	-	BR						
5503-LBC/LBN	BIG INCASSO 570 Foro ø 575mm 46W 4400Lm 700mA	-	BR						
5504-LBC/LBN	BIG INCASSO 770 Foro ø 775mm 84W 8500Lm 700mA	-	BR						
				L = ø 290 - foro 295mm ø 380 385mm ø 570 575mm ø 770 775mm					

a richiesta - on request

IP20

a richiesta - on request

DOWNLIGHTS SQUARE

INCASSI PLAFONE DA INTERNO - RECESSED CEILING DOWNLIGHT



SENZA CORNICE - TRIMLESS

SINDI 60
foro 54x54mm - 8W - 960Lm



SINDI 100
foro 93x93mm - 13,5W - 1000Lm



SINDI 140
foro 136x136mm - 27W - 2200Lm



SINDI 175 SC
foro 178x178mm - 15W - 1400Lm



SINDI 220
foro 225x225mm - 20-30W - 1500-2200Lm



NEW
RULED LINEAR IP INCASSO
foro 60x135/250/365mm - 14-27-40W - 1470-2950-4400Lm



67 x 132
67 x 247
67 x 362

NEW
PLANA INCASSO
foro 130x130mm - 20-40-60W - 2300-4600-6900Lm



123 x 123
123 x 241
123 x 359

NEW
PLANA SEMINCASSO
foro 115x110mm - 20-40-60W - 2300-4600-6900Lm



SINDI 240 SC
foro 238x238mm - 22,4W - 1500Lm



ROSS INCASSO
foro 596x140mm - 47,5W - 6900Lm



600 x 162

DOWNLIGHTS SQUARE



CODICE CODE	DESCRIZIONE DESCRIPTION	FASCIO BEAM	COLORE FINISH		
KT2868-LBC/LBN	SINDI 60 Kit foro 54x54mm 8W 360Lm 200mA + DRIVER	90°	BR		
KT2869-LBC/LBN			NE		
KT2870-LBC/LBN			GA		
KT2860-LBC/LBN	SINDI 100 Kit foro 93x93mm 13,5W 1000Lm 350mA + DRIVER	90°	BR		
KT2861-LBC/LBN			NE		
KT2862-LBC/LBN			GA		
KT2875-LBC/LBN	SINDI 140 Kit foro 136x136mm 27W 2200Lm 700mA + DRIVER	90°	BR		
KT2876-LBC/LBN			NE		
KT2877-LBC/LBN			GA		
4194	SINDI 220 foro 225x225mm 20W 1500Lm 220-240V 3000K	-	BR		
4195			GA		
4196	SINDI 220 foro 225x225mm 20W 1500Lm 220-240V 4000K	-	BR		
4197			GA		
4200	SINDI 220 foro 225x225mm 30W 2200Lm 220-240V 3000K	-	BR		
4201			GA		
4198	SINDI 220 foro 225x225mm 30W 2200Lm 220-240V 4000K	-	BR		
4199			GA		
4152-LBC/LBN	SINDI 175 SC foro 178x178mm 15W 1400Lm 700mA	70°	BR		
4162-LBC/LBN	SINDI 240 SC foro 238x238mm 22,4W 1500Lm 700mA	70°	BR		

IP 54 a richiesta - on request DALI EM

P20 P44

a richiesta - on request DALI EM

IP 20

DOWNLIGHTS SQUARE



CODICE CODE	DESCRIZIONE DESCRIPTION	FASCIO BEAM	COLORE FINISH	
3910-LBC/LBN-75	RULED LINEAR IP INCASSO 3 LED - foro 60x135mm 14W 1470Lm 500mA	75°	BI	
3911-LBC/LBN-75				
3915-LBC/LBN-75	RULED LINEAR IP INCASSO 6 LED - foro 60x250mm 27W 2950Lm 500mA	75°	BI	
3916-LBC/LBN-75				
3920-LBC/LBN-75	RULED LINEAR IP INCASSO 9 LED - foro 60x365mm 40W 4400Lm 500mA	75°	BI	
3921-LBC/LBN-75				

NEW RULED LINEAR IP54 INCASSO



IP 54
IP 54
UGR 19
DALI
a richiesta
on request

DOWNLIGHTS SQUARE



CODICE CODE	DESCRIZIONE DESCRIPTION	FASCIO BEAM	COLORE FINISH
4580-LBC/LBN	PLANA 120 20W 2300Lm 500mA	30°	NE
4585-LBC/LBN	PLANA 240 40W 4600Lm 500mA	30°	NE
4590-LBC/LBN	PLANA 360 60W 6900Lm 500mA	30°	NE
4575	PLANA 120 153x153mm - Kit incasso cornice rasamento - Flush recessed frame kit - TRIMLESS	-	-
4576	PLANA 240 153x270mm - Kit incasso cornice rasamento - Flush recessed frame kit - TRIMLESS	-	-
4577	PLANA 360 153x390mm - Kit incasso cornice rasamento - Flush recessed frame kit - TRIMLESS	-	-
4578	Kit sospensione - Suspension kit - 60x60mm rosone - canopy	-	-
4455-LBC/LBN	ROSS INCASSO foro 596x140mm 47,5W 6900Lm 500mA - fascio/beam FS	FS	BR
4456-LBC/LBN			NE
4457-LBC/LBN	ROSS INCASSO foro 596x140mm 47,5W 6900Lm 500mA - fascio/beam FL	FL	BR
4458-LBC/LBN			NE
4459-LBC/LBN	ROSS INCASSO foro 596x140mm 47,5W 6900Lm 500mA - fascio/beam AS	AS	BR
4460-LBC/LBN			NE
4461-LBC/LBN	ROSS INCASSO foro 596x140mm 47,5W 6900Lm 500mA - fascio/beam BAS	BAS	BR
4462-LBC/LBN			NE

NEW **PLANA INCASSO**

PLANA SEMINCASSO

PLANA 120 115x110mm
PLANA 240 110x210mm
PLANA 360 110x330mm

SEMINCASSO SEMI-RECESSED
 RASAMENTO TRIMLESS

130x130mm
 130x250mm
 130x370mm

foro incasso - recessing hole

IP20 UGR<10 RGO DALI a richiesta on request

ROSS INCASSO

foro 596x140mm

IP40 UGR<19 EM FS FL AS BAS a richiesta on request

**INCASSI MULTIOTTICA
RECESSED MULTIOPTICS**



SENZA CORNICE - TRIMLESS

COIN50 12,5W 

MATRIX COIN MICRO

foro 82x82mm - 12,3W - 1300Lm



MATRIX COIN

foro 118x118mm - 12,3W - 1300Lm



foro 210x118mm - 2x12,3W - 2x1300Lm



foro 295x118mm - 3x 2,3W - 3x1300Lm



foro 210x210mm - 4x12,3W - 4x1300Lm

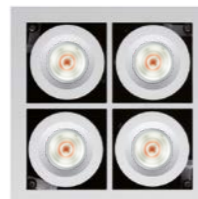

COB 24-47W 

MATRIX MICRO SC

foro 98x98 - 12,9W - 1400Lm

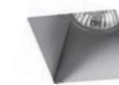

foro 98x180 - 2x12,9W - 2800Lm



90

125

PREVALED 111 25-37W 

MATRIX 111

foro 165x165mm - LED 111



foro 295x165mm - LED 111



foro 435x165mm - LED 111



foro 295x295mm - LED 111



COB 24-47W 

MATRIX POWER

foro 180x180mm - 12,3W - 1300Lm



foro 180x339mm - 27/41W - 2700/4400Lm



PREVALED 111 25-37W 

MATRIX 111 SC

foro 155x155mm - LED 111



foro 285x155mm - LED 111



foro 430x155mm - LED 111



foro 285x285mm - LED 111



180

INCASSI MULTIOTTICA - RECESSED MULTIOPTICS



CODICE CODE	DESCRIZIONE DESCRIPTION	FASCIO BEAM	COLORE FINISH		
71106C-LBC/LBN-15/24/40	MATRIX COIN MICRO foro 82x82mm 12,3W 1300Lm 350mA	15 - 24 - 40°	BI		MATRIX COIN MICRO
71105C-LBC/LBN-15/24/40			GA		
645732	Driver consigliato - Recommended driver ON-OFF IP20 2,5/42W - 150/1050mA	-	-	foro 82x82mm	IP20 a richiesta on request
71106-MLBC-/MLBN-25/40	MATRIX MICRO SC foro 98x98mm 12,3W 1300Lm 350mA	25 - 40°	BR		MATRIX MICRO SC SENZA CORNICE - TRIMLESS
71111-MLBC-/MLBN-25/40	MATRIX MICRO SC foro 98x180mm 2x12,9W 2x1300Lm 350mA - 2 LED	25 - 40°	BR		
3035	ACCESSORI - ACCESSORIES Diffusore in vetro per monolampada - Glass diffuser for single bulb	-	-		
3036	Diffusore in vetro per bilampada - Glass diffuser for double bulb	-	-		
645732	Driver consigliato - Recommended driver ON-OFF IP20 2,5/42W - 150/1050mA	-	-		IP20
71131C-LBC-/LBN-15/24/40	MATRIX COIN foro 118x118mm 12,3W 1300Lm 350mA	15 - 24 - 40°	BI		MATRIX COIN
71130C-LBC-/LBN-15/24/40			GA		
71136C-LBC-/LBN-15/24/40	MATRIX COIN foro 210x118mm 2x12,3W 2x1300Lm 350mA - 2 LED	15 - 24 - 40°	BI		
71135C-LBC-/LBN-15/24/40			GA		
7116C-LBC-/LBN-15/24/40	MATRIX COIN foro 295x118mm 3x12,3W 3x1300Lm 350mA - 3 LED	15 - 24 - 40°	BI		
7115C-LBC-/LBN-15/24/40			GA		
71121C-LBC-/LBN-15/24/40	MATRIX COIN foro 210x210mm 4x12,3W 4x1300Lm 350mA - 4 LED	15 - 24 - 40°	BI		
71120C-LBC-/LBN-15/24/40			GA		
INV 1052	ACCESSORI - ACCESSORIES Kit emergenza - Emergency kit - 1H	-	-		
INV 1052-3	Kit emergenza - Emergency kit - 3H	-	-		
645732	Driver consigliato - Recommended driver ON-OFF IP20 2,5/42W - 150/1050mA	-	-		IP20 a richiesta - on request

INCASSI MULTIOTTICA - RECESSED MULTIOPTICS



CODICE CODE	DESCRIZIONE DESCRIPTION	COLORE FINISH		
70101	MATRIX 111 foro 165x165mm - LED 111	BI	 foro 165x165mm	
70100		GR		
70201	MATRIX 111 foro 295x165mm - LED 111 - 2 LED	BI	 foro 295x165mm	
70200		GR		
70301	MATRIX 111 foro 435x165mm - LED 111 - 3 LED	BI	 foro 435x165mm	
70300		GR		
70411	MATRIX 111 foro 295x295mm - LED 111 - 4 LED	BI	 foro 295x295mm	 <p>Gli apparecchi non sono muniti nè di lampada nè di driver che potranno essere ordinati a SIDE a seconda del tipo di fascio e di potenza desiderata. The fixtures are not equipped with lamp or a power supply which can be ordered from SIDE according to the type of beam and desired power.</p>
70410		GR		
70101-SC	MATRIX 111 SC foro 155x155mm senza cornice/trimless - LED 111	BI	 foro 155x155mm	
70100-SC		GR		
70201-SC	MATRIX 111 SC foro 285x155mm senza cornice/trimless - LED 111 - 2 LED	BI	 foro 285x155mm	
70200-SC		GR		
70301-SC	MATRIX 111 SC foro 430x155mm senza cornice/trimless - LED 111 - 3 LED	BI	 foro 430x155mm	
70300-SC		GR		
70411-SC	MATRIX 111 SC foro 285x285mm senza cornice/trimless - LED 111 - 4 LED	BI	 foro 285x285mm	 <p>Gli apparecchi non sono muniti nè di lampada nè di driver che potranno essere ordinati a SIDE a seconda del tipo di fascio e di potenza desiderata. The fixtures are not equipped with lamp or a power supply which can be ordered from SIDE according to the type of beam and desired power.</p>
70410-SC		GR		

INCASSI MULTIOTTICA - RECESSED MULTIOPTICS



CODICE CODE	DESCRIZIONE DESCRIPTION	FASCIO BEAM	COLORE FINISH		
70501-LBC/LBN-30/60	MATRIX POWER foro 180x180mm 27W 2700Lm	30 - 60°	BR		
70500-LBC/LBN-30/60			GA		
70506-LBC/LBN-30/60	MATRIX POWER foro 180x180mm 41W 4400Lm	30 - 60°	BR		
70505-LBC/LBN-30/60			GA		
70511-LBC/LBN-30/60	MATRIX POWER foro 180x180mm 47W 4600Lm - PLUS	30 - 60°	BR		
70510-LBC/LBN-30/60			GA		
70601-LBC/LBN-30/60	MATRIX POWER foro 180x339mm 2x27W 2x2700Lm - 2 LED	30 - 60°	BR		
70600-LBC/LBN-30/60			GA		
70606-LBC/LBN-30/60	MATRIX POWER foro 180x339mm 2x41W 2x4400Lm - 2 LED	30 - 60°	BR		
70605-LBC/LBN-30/60			GA		
70615-LBC/LBN-30/60	MATRIX POWER foro 180x339mm 2x47W 2x4600Lm - PLUS - 2 LED	30 - 60°	BR		
70616-LBC/LBN-30/60			GA		
INV 1052	ACCESSORI - ACCESSORIES Kit emergenza - Emergency kit - 1H	-	-		
INV 1052-3	Kit emergenza - Emergency kit - 3H	-	-		



MATRIX



MATRIX SC SENZA CORNICE - TRIMLESS



APPARECCHIO SENZA LAMPADA FITTINGS WITHOUT LAMP

MATRIX



MATRIX SC SENZA CORNICE - TRIMLESS



LAMPADA - BULB PREVALED COIN 111



Codice Code	Watt	Volt	Attacco Socket	Fascio Beam	Lumen	Cd*	Kelvin
646338-930	26W	700mA	-	15°	2350	-	3000K
646338-940	26W	700mA	-	15°	2500	-	4000K
646339-930	26W	700mA	-	24°	2250	-	3000K
646339-940	26W	700mA	-	24°	2400	-	4000K
646340-930	26W	700mA	-	40°	2150	-	3000K
646340-940	26W	700mA	-	40°	2300	-	4000K
646347-930	37W	1050mA	-	24°	2450	-	3000K
646347-940	37W	1050mA	-	24°	3800	-	4000K
646348-930	37W	1050mA	-	40°	3350	-	3000K
646348-940	37W	1050mA	-	40°	3550	-	4000K

DRIVER



Codice Code	Watt	n° max lamp
646349-I	30W	1
646168-I	40W	1

50

STILO 28 INCASSO

foro 50mm - 4W - 500Lm



60

BEND MINI INCASSO

foro 60mm - 14,4W - 1400Lm



STILO 60 BASE INCASSO

foro 60mm - 14,4W - 1400Lm



120

STILO 60 INCASSO TONDO

foro 107mm - 14,4W - 1700Lm



135

BEND XS ESTRAIBILE

foro 125mm - 27W - 2800Lm

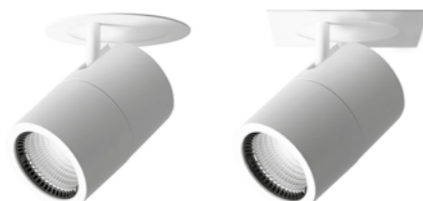

BEND XS ESTRAIBILE

foro 254x118mm - 51W - 5700Lm



145

STILO 60 INCASSO QUADRO

foro 136x136mm - 14,4W - 1700Lm



170







TOR 15 ORIENTABILE

foro 156mm - 35W - 3800Lm

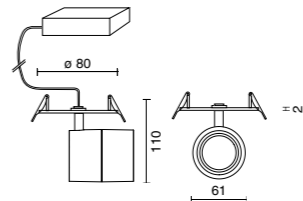

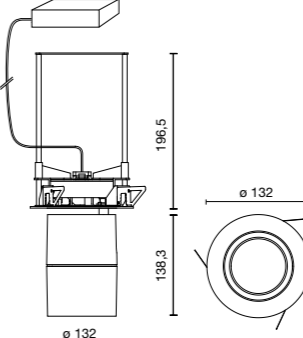
PROIETTORI DA INCASSO ORIENTABILI - RECESSED ADJUSTABLE SPOTS

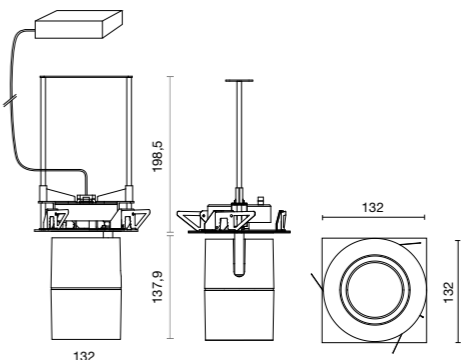

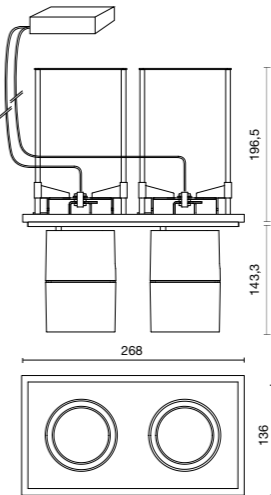
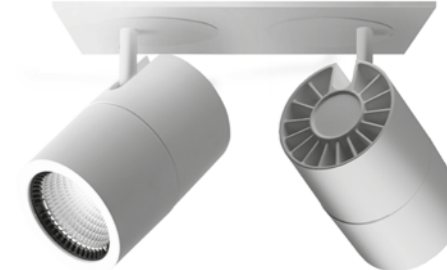
CODICE CODE	DESCRIZIONE DESCRIPTION	FASCIO BEAM	COLORE FINISH	
67395-LBC/LBN-20M/40M	BEND MINI INCASSO - RECESSED Foro ø 60mm 14,4W 1400Lm 350mA	20 - 40°	BR	BEND MINI INCASSO  foro 60mm  IP 20
67396-LBC/LBN-20M/40M			NE	
68035-LBC/LBN-25/40	BEND XS ESTRAIBILE-ORIENTABILE - RETRACTIBLE-ADJUSTABLE Foro ø 125mm 27W 2800Lm 700mA	25 - 40°	BR	BEND XS ESTRAIBILE-ORIENTABILE  foro 125mm  a richiesta on request IP 20
68036-LBC/LBN-25/40			NE	
68037-LBC/LBN-25/40			GR	
68038-LBC/LBN-25/40	BEND XS ESTRAIBILE-ORIENTABILE FLANGIA QUADRATA - RETRACTIBLE-ADJUSTABLE SQUARE PLATE Foro ø 125mm 27W 2800Lm 700mA	25 - 40°	BR	BEND XS ESTRAIBILE-ORIENTABILE FLANGIA QUADRATA  foro 125mm  a richiesta on request IP 20
68039-LBC/LBN-25/40			NE	
68040-LBC/LBN-25/40			GR	
68041-LBC/LBN-25/40	BEND XS ESTRAIBILE-ORIENTABILE FLANGIA RETTANGOLARE - RETRACTIBLE-ADJUSTABLE RECTANGULAR PLATE Foro ø 254x118mm 51W 5700Lm 700mA	25 - 40°	BR	BEND XS ESTRAIBILE-ORIENTABILE FLANGIA RETTANGOLARE  foro 254x118mm  a richiesta on request IP 20
68042-LBC/LBN-25/40			NE	
68043-LBC/LBN-25/40			GR	

PROIETTORI DA INCASSO ORIENTABILI - RECESSED ADJUSTABLE SPOTS



CODICE CODE	DESCRIZIONE DESCRIPTION	FASCIO BEAM	COLORE FINISH		
67815-LBC/LBN-8/30	STILO 28 INCASSO/RECESSED Foro ø 50mm 4W 500Lm 350mA	8 - 30°	BR		STILO 28 INCASSO a richiesta on request IP 20
67816-LBC/LBN-8/30			NE		
646098	Driver consigliato - Recommended driver ON-OFF 8W IP20 350mA	-	-		
68044-LBC/LBN-19/27/38/56	STILO 60 INCASSO TONDO/ROUND Foro ø 107mm 14,4W 1700Lm 400mA	19 - 27 - 38 - 56°	BR		STILO 60 INCASSO TONDO a richiesta - on request IP 20
68045-LBC/LBN-19/27/38/56			NE		
68046-LBC/LBN-19/27/38/56			GR		
3126-1/2/3/4/5	ACCESSORI - ACCESSORIES Cornice frontale - Frontal ring	-	BR-NE ORO-SILVER RAL a rich.	 3126 3114 - 3115 3117 3119 3121 - 3123	
3114	Cilindro di schermatura - Cylinder	-	BR		
3115		-	NE		
3117	Griglia alveolare - Honeycomb	-	NE		
3119	Cono frangiluce Spillring - Cone Spillring	-	NE		
3121	Lente Ellittica - Elliptical lens	-	-		
3123	Lente diffondente - Diffused lens	-	-		
645984	Driver consigliato - Recommended driver ON-OFF 15W IP20 350mA	-	-		
68055-LBC/LBN-19/27/38/56	STILO 60 INCASSO QUADRO/SQUARE Foro ø 136x136mm 14,4W 1700Lm 400mA	19 - 27 - 38 - 56°	BR		STILO 60 INCASSO QUADRO a richiesta - on request IP 20
68056-LBC/LBN-19/27/38/56		19 - 27 - 38 - 56°	NE		
68057-LBC/LBN-19/27/38/56		19 - 27 - 38 - 56°	GR		
3126-1/2/3/4/5	ACCESSORI - ACCESSORIES Cornice frontale - Frontal ring	-	BR-NE ORO-SILVER RAL a rich.	 3126 3114 - 3115 3117 3119 3121 - 3123	
3114	Cilindro di schermatura - Cylinder	-	BR		
3115		-	NE		
3117	Griglia alveolare - Honeycomb	-	NE		
3119	Cono frangiluce Spillring - Cone Spillring	-	NE		
3121	Lente Ellittica - Elliptical lens	-	-		
3123	Lente diffondente - Diffused lens	-	-		
645984	Driver consigliato - Recommended driver ON-OFF 15W IP20 350mA	-	-		

PROIETTORI DA INCASSO ORIENTABILI - RECESSED ADJUSTABLE SPOTS



CODICE CODE	DESCRIZIONE DESCRIPTION	FASCIO BEAM	COLORE FINISH		STILO 60 BASE INCASSO
67880-LBC/LBN-6/19/27/38/56M			BR		
67881-LBC/LBN-6/19/27/38/56M	STILO 60 INCASSO Foro \varnothing 60mm 22,5W 1800Lm 500mA	6 - 19 - 27 - 38 - 56°	NE		
67882-LBC/LBN-6/19/27/38/56M			GR	foro 60mm	
2929C-LBC/LBN-S/FL/WF	TOR 15 ORIENTABILE/ADJUSTABLE Foro \varnothing 156mm 35W 3800Lm 900mA	10 - 30 - 40°	BI	 foro 156mm	TOR 15 ORIENTABILE
INV 1052	ACCESSORI - ACCESSORIES Kit emergenza Emergency kit- 1H	-	-	 ANELLO DI COMPENSAZIONE COMPENSATION RING	a richiesta - on request
INV 1052-3	Kit emergenza Emergency kit - 3H	-	-		
122	Anello di compensazione - Compensation ring				

PROIETTORI A BINARIO ELETTRIFICATO - SPOT FOR TRACK



A RICHIESTA - ON REQUEST

28		STILO 28 5,5W - 510Lm				
42		STILO 42 14,4W - 1100Lm				
60		STILO 60 16/22,5W - 1400/1800Lm	BEND SLIM MINI 14,4W - 1400Lm	NEW RULED LINEAR IP BINARIO 14/27/40W - 1470/2950/4400Lm		
90	BEND XS 2019 35W - 3300Lm BEST SELLER	NEW BEND 2023 27W - 2700Lm	BEND SLIM XS 27/35W - 2800/3700Lm	SHORT XS 33,5W - 3100Lm	SHORT ZOOM 35W - 3800Lm Fascio regolabile da 10° ± 60° Adjustable optics from 10° ± 60°	LUXOR XS 35W - 3700Lm
110			BEND SLIM M 41W - 4200Lm	SHORT M 41W - 3500Lm		LUXOR XL 41/47W - 4400/4900Lm
130			BEND SLIM XL 41W - 4200Lm	NEW PLANA 20W - 2300Lm 40W - 4600Lm		
140						SIRIUS 41/47W - 4400/5000Lm
160				VEGA XS 16,5W - 1100Lm	SOLARIS MINI 14,4W - 1100Lm	
200				VEGA XL 64W - 4100Lm	SOLARIS 44W - 5200Lm	
MAXI				BIG BINARIO 16/21W - 1500/2100Lm		ROSS BINARIO 43,51W - 7200Lm

PROIETTORI A BINARIO ELETRIFICATO - SPOT FOR TRACK



CODICE CODE	DESCRIZIONE DESCRIPTION	FASCIO BEAM	COLORE FINISH		
67825-LBC/LBN-8/30	STILO 28 5,5W 500Lm 48Vdc - con adattatore per binario 48Vdc/for track 48Vdc	8 - 30°	BR		
67826-LBC/LBN-8/30			NE		
67827-LBC/LBN-8/30			GR		
67830-LBC/LBN-15/24/36	STILO 42 14,4W 1100Lm 350mA - con adattatore SLIM/with SLIM adapter	15 - 24 - 36°	BR		
67831-LBC/LBN-15/24/36			NE		
67832-LBC/LBN-15/24/36			GR		
67835-LBC/LBN-15/24/36	STILO 42 14,4W 1100Lm 48Vdc - con adattatore per binario 48Vdc/for track 48Vdc	15 - 24 - 36°	BR		
67836-LBC/LBN-15/24/36			NE		
67837-LBC/LBN-15/24/36			GR		
3125-1/2/3/4/5	ACCESSORI - ACCESSORIES Cornice frontale - Frontal ring	-	BR-NE ORO-SILVER RAL a rich.		
3112	Cilindro di schermatura - Snoot	-	BR		3112 - 3113
3113		-	NE		
3116	Griglia alveolare - Honeycomb grid	-	NE		3116
3118	Cono frangiluce Spillring - Cone Spillring	-	NE		3118
3120	Lente Ellittica - Elliptical lens	-	-		3120 - 3122
3122	Lente diffondente - Diffused lens	-	-		

a richiesta on request
IP 20 48Vdc DALI

IP 20

a richiesta on request
IP 20 48Vdc DALI

PER BINARIO 48Vdc - ST2/5
VERSIONE SPECIALE CON TIGE LUNGA 568730XX

FOR TRACK 48Vdc - ST2/5
SPECIAL VERSION WITH LONG STEM 568730XX









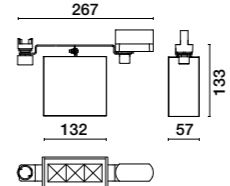

PROIETTORI A BINARIO ELETTRIFICATO - SPOT FOR TRACK

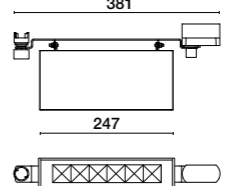

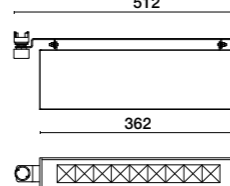
CODICE CODE	DESCRIZIONE DESCRIPTION	FASCIO BEAM	COLORE FINISH		
67870-LBC/LBN-6/19/27/38/56	STILO 60 SHORT 16W 1400Lm 400mA - con adattatore SLIM/with SLIM adapter	6 - 19 - 27 - 38 - 56°	BR		
67871-LBC/LBN-6/19/27/38/56			NE		
67872-LBC/LBN-6/19/27/38/56			GR		
67840-LBC/LBN-6/19/27/38/56	STILO 60 22,5W 1800Lm 500mA - con adattatore SLIM/with SLIM adapter	6 - 19 - 27 - 38 - 56°	BR		
67841-LBC/LBN-6/19/27/38/56			NE		
67842-LBC/LBN-6/19/27/38/56			GR		
67883-LBC/LBN-6/19/27/38/56	STILO 60 22,5W 1800Lm 500mA - con adattatore SLIM/with SLIM adapter	6 - 19 - 27 - 38 - 56°	BR		
67884-LBC/LBN-6/19/27/38/56			NE		
67885-LBC/LBN-6/19/27/38/56			GR		
67880-LBC/LBN-6/19/27/38/56	STILO 60 22,5W 1800Lm 500mA - con basetta/with base	6 - 19 - 27 - 38 - 56°	BR		
67881-LBC/LBN-6/19/27/38/56			NE		
67882-LBC/LBN-6/19/27/38/56			GR		
67845-LBC/LBN-6/19/27/38/56	STILO 60 22,5W 1800Lm 48Vdc - con adattatore per binario 48Vdc/for track 48Vdc	6 - 19 - 27 - 38 - 56°	BR		
67846-LBC/LBN-6/19/27/38/56			NE		
67847-LBC/LBN-6/19/27/38/56			GR		
990925	ACCESSORI - ACCESSORIES Basetta plafone per adattatore elettrico (solo per versione on-off) - Surface mounted adaptor only on-off	-	BI		
990926			NE		
990930	Adattatore per incasso basetta - Surface mounted adaptor only on-off	-	BI		
990931			NE		
3126-1/2/3/4/5	Cornice frontale - Frontal ring	-	BR-NE ORO-SILVER RAL a rich.		3126
3114	Cilindro di schermatura - Shielding cylinder	-	BR		3114 - 3115
3115			NE		
3117	Griglia alveolare - Honeycomb	-	NE		3117
3119	Cono frangiluce Spillring - Cone Spillring	-	NE		3119
3121	Lente Ellittica - Elliptical lens	-	-		3121 - 3123
3123	Lente diffondente - Diffused lens	-	-		

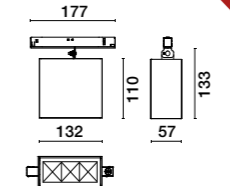
PROIETTORI A BINARIO ELETTRIFICATO - SPOT FOR TRACK

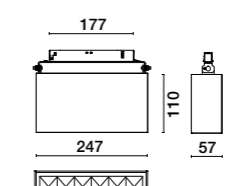

CODICE CODE	DESCRIZIONE DESCRIPTION	FASCIO BEAM	COLORE FINISH	
3885-LBC/LBN-75	RULED LINEAR IP54 BINARIO 230V 3 LED - L. 132mm - 14W 1470Lm 500mA	75°	NE	<p>NEW RULED LINEAR IP BINARIO 230V</p>  
3890-LBC/LBN-75	RULED LINEAR IP54 BINARIO 230V 6 LED - L. 247mm - 27W 2950Lm 500mA	75°	NE	 
3895-LBC/LBN-75	RULED LINEAR IP54 BINARIO 230V 9 LED - L. 362mm - 40W 4400Lm 500mA	75°	NE	  <p>a richiesta on request</p> <p>IP 20 UGR < 19 DALI </p>
3900-LBC/LBN-75	RULED LINEAR IP54 BINARIO 48V 3 LED - L. 132mm - 14W 1470Lm 48Vdc	75°	NE	<p>NEW RULED LINEAR IP BINARIO 48V</p>  
3905-LBC/LBN-75	RULED LINEAR IP54 BINARIO 48V 6 LED - L. 247mm - 27W 2950Lm 48Vdc	75°	NE	  <p>a richiesta on request</p> <p>IP 20 48Vdc UGR < 19 DALI </p>

PROIETTORI A BINARIO ELETTRIFICATO - SPOT FOR TRACK



CODICE CODE	DESCRIZIONE DESCRIPTION	FASCIO BEAM	COLORE FINISH		
67308-LBC/LBN-15/40/60	<p>BEND XS 2019 35W 3300Lm 900mA</p>	15 - 40 - 60°	BR		<p>BEND XS 2019</p>
67309-LBC/LBN-15/40/60			NE		
67310-LBC/LBN-15/40/60			GR		
3079	<p>ACCESSORI - ACCESSORIES Griglia alveolare - Honeycomb</p>	-	-	<p>3079</p>	<p>a richiesta - on request</p>
67410-LBC/LBN-20/35	<p>BEND 2023 27W 2600Lm 700mA</p>	20 - 35°	BR		<p>NEW BEND 2023</p>
67411-LBC/LBN-20/35			NE		<p>a richiesta on request</p>

PROIETTORI A BINARIO ELETRIFICATO - SPOT FOR TRACK



CODICE CODE	DESCRIZIONE DESCRIPTION	FASCIO BEAM	COLORE FINISH		
67395-LBC/LBN-20/40	BEND SLIM MINI 14,4W 1400Lm 350mA	20 - 40°	BR		<p>BEND SLIM MINI</p>
67396-LBC/LBN-20/40			NE		
67335-LBC/LBN-15/25/40	BEND SLIM XS 27W 2900Lm 700mA	15 - 25 - 40°	BR		<p>BEND SLIM XS</p>
67336-LBC/LBN-15/25/40			NE		
67335P-LBC/LBN-15/25/40	BEND SLIM XS 35W 3700Lm 900mA - PLUS	15 - 25 - 40°	BR		<p>BEND SLIM XS</p>
67336P-LBC/LBN-15/25/40			NE		
3014-BR/NE	ACCESSORI - ACCESSORIES Alette direzionali - Directional fins	-	BR - NE	<p>3014</p>	<p>BEND SLIM M</p>
3079	Griglia alveolare - Honeycomb	-	-	<p>3079</p>	
3079-1/2	Schermo asimmetrico con vetro prismatico - Asymmetrical screen with prismatic glass	-	BR - NE	<p>3079-1</p>	
67355-LBC/LBN-15/30/60	BEND SLIM M 41W 4200Lm 1050mA	15 - 30 - 60°	BR		<p>BEND SLIM M</p>
67356-LBC/LBN-15/30/60			NE		
67357-LBC/LBN-15/30/60			GR		
3031-BR/NE/GA	ACCESSORI - ACCESSORIES Alette direzionali - Directional fins	-	BR-NE-GA	<p>3031</p>	<p>a richiesta on request</p>
67305K-LBC/LBN-25/60	BEND SLIM XL 41W 4200Lm 1050mA	25 - 60°	BR		<p>BEND SLIM XL</p>
67306K-LBC/LBN-25/60			NE		

PROIETTORI A BINARIO ELETRIFICATO - SPOT FOR TRACK



CODICE CODE	DESCRIZIONE DESCRIPTION	FASCIO BEAM	COLORE FINISH		
67325-LBC/LBN12AG/25AG/40AG	SHORT XS 33,5W 3100Lm 800mA	12 - 25 - 40°	BR		<p>SHORT XS</p>
67326-LBC/LBN12AG/25AG/40AG			NE		
3014-BR/NE	ACCESSORI - ACCESSORIES Alette direzionali - Directional fins	-	BR - NE	<p>3014</p>	<p>a richiesta - on request</p>
67397-LBC/LBN12AG/25AG/40AG	SHORT M 41W 3500Lm 1050mA	12 - 25 - 40°	BR		<p>SHORT M</p>
67398-LBC/LBN12AG/25AG/40AG			NE		
3031-BR/NE	ACCESSORI - ACCESSORIES Alette direzionali - Directional fins	-	BR - NE	<p>3031</p>	<p>a richiesta - on request</p>
67405-LBC/LBN	SHORT ZOOM 35W 3800Lm 900mA	10 ± 60°	BR		<p>SHORT ZOOM</p>
67406-LBC/LBN			NE	<p>Fascio regolabile da 10° ± 60° Adjustable optics from 10° ± 60°</p>	

PROIETTORI A BINARIO ELETRIFICATO - SPOT FOR TRACK



CODICE CODE	DESCRIZIONE DESCRIPTION	FASCIO BEAM	COLORE FINISH		
67780-LBC/LBN	VEGA XS BINARIO 16,5W 1100Lm 500mA	30°	BR		
67781-LBC/LBN			NE		
67782-LBC/LBN			GR		
67780-LBC/LBN-60	VEGA XS BINARIO 16,5W 1100Lm 500mA	60°	BR		
67781-LBC/LBN-60			NE		
67782-LBC/LBN-60			GR		
67790-LBC/LBN	VEGA XL BINARIO 64W 4100Lm 700mA	30°	BR		
67791-LBC/LBN			NE		
67792-LBC/LBN			GR		
67790-LBC/LBN-60	VEGA XL BINARIO 64W 4100Lm 700mA	60°	BR		
67791-LBC/LBN-60			NE		
67792-LBC/LBN-60			GR		
67963-LBC/LBN	SOLARIS MINI BINARIO 19,3W 1450Lm 450mA	SIM	BR		
67964-LBC/LBN			NE		
67965-LBC/LBN			GR		
67969-LBC/LBN	SOLARIS MINI BINARIO 19,3W 1360Lm 450mA	ASIM	BR		
67970-LBC/LBN			NE		
67971-LBC/LBN			GR		
67953-LBC/LBN	SOLARIS BINARIO 38W 5200Lm 525mA	ASIM	BR		
67953-LBC/LBN-B			BR		
67954-LBC/LBN			NE		
67955-LBC/LBN			GR		
a richiesta - on request IP 20 DIM 1÷10 DALI					
5505EU-LBC/LBN	BIG BINARIO 270 16W 1500Lm 500mA	-	BR		
5506EU-LBC/LBN			NE		
5507EU-LBC/LBN			GR		
5513EU-LBC/LBN	BIG BINARIO 380 21W 2100Lm 700mA	-	BR		
5514EU-LBC/LBN			NE		
5515EU-LBC/LBN			GR		

PROIETTORI A BINARIO ELETTRIFICATO - SPOT FOR TRACK



CODICE CODE	DESCRIZIONE DESCRIPTION	FASCIO BEAM	COLORE FINISH		
6773-LBC/LBN-15/25/40	LUXOR XS 35W 3800Lm 900mA	15 - 25 - 40°	BR		LUXOR XS 
6774-LBC/LBN-15/25/40			NE		
6775-LBC/LBN-15/25/40			GR		
67800-LBC/LBN-30/60	LUXOR XL 41W 4400Lm 1050mA	30 - 60°	BR		LUXOR XL 
67801-LBC/LBN-30/60			NE		
67802-LBC/LBN-30/60			GR		
67808-LBC/LBN-30/60	LUXOR XL 47W 4900Lm 1200mA - PLUS	30 - 60°	BR		
67809-LBC/LBN-30/60			NE		
67810-LBC/LBN-30/60			GR		
67191-LBC/LBN/-40/60	SIRIUS 41W 4400Lm 1050mA	20 - 40 - 60°	BR		SIRIUS 
67192-LBC/LBN/-40/60			NE		
67193-LBC/LBN/-40/60			GR		
67194-LBC/LBN/-40/60	SIRIUS 47W 5000Lm 1200mA - PLUS	20 - 40 - 60°	BR		
67195-LBC/LBN/-40/60			NE		
67196-LBC/LBN/-40/60			GR		

a richiesta on request
IP 20 DALI

a richiesta - on request
IP 20 FOOD DALI

a richiesta - on request
IP 20 FOOD DALI

PROIETTORI A BINARIO ELETTRIFICATO - SPOT FOR TRACK

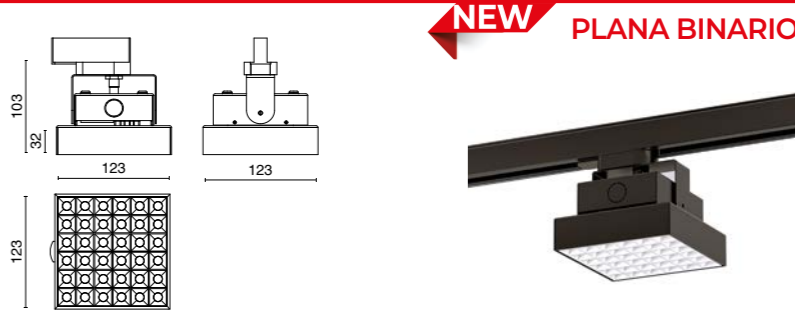
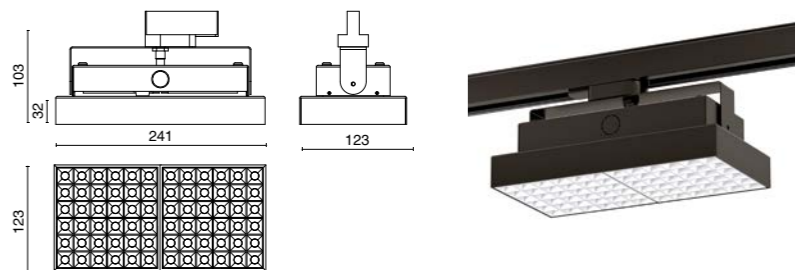
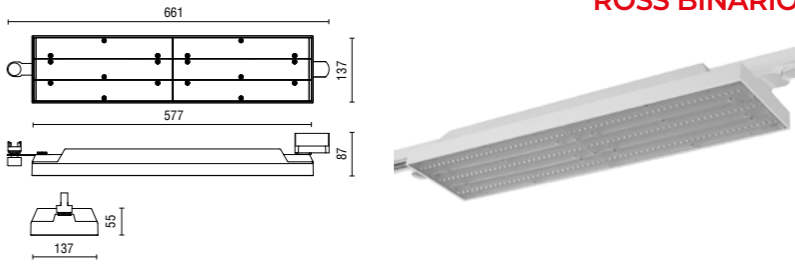

CODICE CODE	DESCRIZIONE DESCRIPTION	FASCIO BEAM	COLORE FINISH	 <p>NEW PLANA BINARIO</p>
4580EU-LBC/LBN	PLANA 120 20W 2300Lm 500mA	30°	NE	
4585EU-LBC/LBN	PLANA 240 40W 4600Lm 500mA	30°	NE	 <p>orientabile - Adjustable 355°</p> <p>orientabile - Adjustable +/-30°</p> <p>IP 20 UGR <math>\leq 10</math> RG0</p> <p>a richiesta on request BALI</p>
4445-LBC/LBN	ROSS BINARIO 47,5W 6900Lm 500mA - fascio/beam FS	FS	BR	 <p>ROSS BINARIO</p>
4446-LBC/LBN		NE		
4447-LBC/LBN	ROSS BINARIO 47,5W 6900Lm 500mA - fascio/beam FL	FL	BR	
4448-LBC/LBN		NE		
4449-LBC/LBN	ROSS BINARIO 47,5W 6900Lm 500mA - fascio/beam AS	AS	BR	
4450-LBC/LBN		NE		
4451-LBC/LBN	ROSS BINARIO 47,5W 6900Lm 500mA - fascio/beam BAS	BAS	BR	
4450-LBC/LBN		NE		

BINARIO ELETRIFICATO - TRACK



CODICE CODE	DESCRIZIONE DESCRIPTION	COLORE FINISH		
25101	BINARIO TRIFASE - 3 CIRCUIT TRACK 1 m	BI		
25102		NE		
25103		GA		
25201	BINARIO TRIFASE - 3 CIRCUIT TRACK 2 m	BI		
25202		NE		
25203		GA		
25301	BINARIO TRIFASE - 3 CIRCUIT TRACK 3 m	BI		
25302		NE		
25303		GA		
25401	BINARIO TRIFASE - 3 CIRCUIT TRACK 4 m	BI		
25402		NE		
25403		GA		
990241	Testata di alimentazione - contatto sinistro di messa a terra - Live end - Left earth contact	BI		
990242	Testata di alimentazione - contatto destro di messa a terra - Live end - Right earth contact	NE		
990251	Testata di alimentazione - contatto destro di messa a terra - Live end - Right earth contact	BI		
990252		NE		
990371	Congiunzione rettilinea - Straight coupler	BI		
990372		NE		
990781	Alimentatore centrale - Straight coupler for central feeding	BI		
990782		NE		
990741	Staffa di fissaggio meccanico - Mechanical fixing clip	BI		
990742		NE		
990791	Congiunzione a 90° - Contatto di terra esterno - 90° Coupler - Outside earth contact	BI		
990792		NE		
990271	Congiunzione a 90° - Contatto di terra interno - 90° Coupler - Inside earth contact	BI		
990272		NE		
990289	Congiunzione a T - Contatto di terra destro esterno - T coupler for surface - Outside left earth contact	BI		
990290		NE		
990293	Congiunzione a T - Contatto di terra sinistro esterno - T coupler for surface - Outside right earth contact	BI		
990294		NE		
990291	Congiunzione a T - Contatto di terra destro interno - T coupler for surface - Inside left earth contact	BI		
990292		NE		
990301	Congiunzione a T - Contatto di terra sinistro interno - T coupler for surface - Inside right earth contact	BI		
990302		NE		
990311	Congiunzione a X - X Coupler for surface	BI		
990312		NE		
990331	Curva flessibile - Flexible curve	BI		
990332		NE		
990341	Copribinario - Track cover 1m.	BI		
990342		NE		

SITRACK 230V
BINARIO PER MONTAGGIO A PLAFONE
TRACK FOR CEILING MOUNTING

SITRACK 230V
ACCESSORI - ACCESSORIES

IP 20

BINARIO ELETTRIFICATO - TRACK

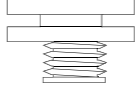
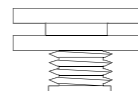
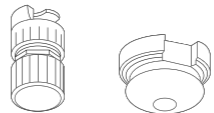
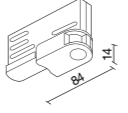
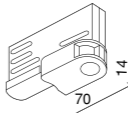
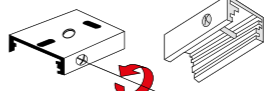
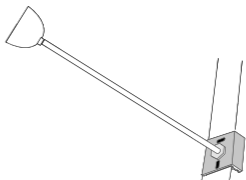
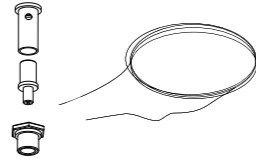
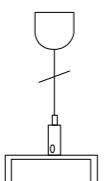
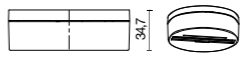
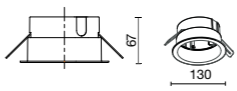

SITRACK 230V
ACCESSORI - ACCESSORIES

CODICE CODE	DESCRIZIONE DESCRIPTION	COLORE FINISH	
990351	Testata di chiusura - End cap	BI	
990352		NE	
588123	Raccordo per adattatore - Nipple for adaptor 100N M13 x 1	-	
588223	Raccordo per adattatore - Nipple for adaptor 100N M10 x 1	-	
644579	Raccordo per adattatore - Nipple for adaptor 50N M10 x 1	-	
644580	Raccordo per adattatore - Nipple for adaptor 50N M13 x 1	-	
990991	Adattatore - Adaptor 100N meccanico universale	BI	
990992		NE	
990831	Bloccacavo per adattatore - Cable clamp for adaptor	BI	
990832		NE	
990921	Adattatore - Adaptor 100N	BI	
990922		NE	
644522	Adattatore - Adaptor 50N	BI	
644523		NE	
990751	Staffa per montaggio a plafone o a sospensione - Clip for surface or pendant mounting	BI	
990752		NE	
999051	Tiges con rosone per montaggio a sospensione - Tiges for pendant mounting - L.600 mm	BI	
999052		NE	
999061	Tiges con rosone per montaggio a sospensione - Tiges for pendant mounting - L.1200 mm	BI	
999062		NE	
7011	Kit sospensione a filo L.5 m per sospensione (ordinare anche staffa) Wire suspension kit L.5 m for suspension, you should order also clip	BI	
7014 BI	Kit sospensione a filo L.3 m per sospensione, completo di staffa (regolabile dal basso) Wire suspension kit L.3 m for suspension, complete with bracket (adjustable from the bottom)	BI	
7014 NE		NE	
990925	Basetta plafone per adattatore (solo per versione on-off) Ceiling base for adaptor (only for on-off version)	BI	
990926		NE	
990930	Adattatore incasso basetta - Recessed base adaptor	BI	
990931		NE	

108,5 mm

BINARIO ELETRIFICATO - TRACK



CODICE CODE	DESCRIZIONE DESCRIPTION	COLORE FINISH		
25101-DA	BINARIO TRIFASE - 3 CIRCUIT TRACK 1 m	BI		
25102-DA		NE		
25201-DA	BINARIO TRIFASE - 3 CIRCUIT TRACK 2 m	BI		
25202-DA		NE		
25301-DA	BINARIO TRIFASE - 3 CIRCUIT TRACK 3 m	BI		
25302-DA		NE		
990241-DA	Testata di alimentazione - contatto sinistro di messa a terra - Live end - Left earth contact	BI		
990242-DA		NE		
990251-DA	Testata di alimentazione - contatto destro di messa a terra - Live end - Right earth contact	BI		
990252-DA		NE		
990781-DA	Alimentatore centrale - Straight coupler for central feeding	BI		
990782-DA		NE		
990791-DA	Congiunzione a 90° - Contatto di terra esterno - 90° Coupler - Outside earth contact	BI		
990792-DA		NE		
990271-DA	Congiunzione a 90° - Contatto di terra interno - 90° Coupler - Inside earth contact	BI		
990272-DA		NE		
990289-DA	Congiunzione a T - Contatto di terra destro esterno - T coupler for surface - Outside left earth contact	BI		
990290-DA		NE		
990293-DA	Congiunzione a T - Contatto di terra sinistro esterno - T coupler for surface - Outside right earth contact	BI		
990294-DA		NE		
990291-DA	Congiunzione a T - Contatto di terra destro interno - T coupler for surface - Inside left earth contact	BI		
990292-DA		NE		
990301-DA	Congiunzione a T - Contatto di terra sinistro interno - T coupler for surface - Inside right earth contact	BI		
990302-DA		NE		
990311-DA	Congiunzione a X - X Coupler for surface	BI		
990312-DA		NE		
990371-DA	Congiunzione rettilinea - Straight coupler	BI		
990372-DA		NE		
646759	Adattatore slim 6 conduttori - Slim adaptor 6 conductor	BI		
646758		NE		
990921-DA	Adattatore 6 conduttori - Adaptor 6 conductor	BI		
990922-DA		NE		









SITRACK 230V DALI
BINARIO PER MONTAGGIO A PLAFONE
TRACK FOR CEILING MOUNTING

ACCESSORI - ACCESSORIES

BINARIO ELETTRIFICATO - TRACK

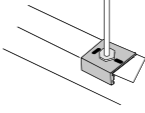

CODICE CODE	DESCRIZIONE DESCRIPTION	COLORE FINISH	
990751-DA	Staffa per montaggio a plafone - Clip for ceiling mounting	BI	
990752-DA		NE	
990351-DA	Testata di chiusura - End cap	BI	
990352-DA		NE	
990341-DA	Copribinario - Track cover	BI	
990342-DA		NE	
999051-DA	Tiges con rosone per montaggio a sospensione - Tiges for pendant mounting - L.600 mm	BI	
999052-DA		NE	
999061-DA	Tiges con rosone per montaggio a sospensione - Tiges for pendant mounting - L.1200 mm	BI	
999062-DA		NE	
7011-DA-BR	Kit sospensione a filo L.3 m per sospensione (ordinare anche staffa cod. 990751-990752) Wire suspension kit L.3 m for suspension, (you should order also clip cod. 990751-990752)	BI	
7011-DA-NE		NE	
912900	Tronchese per taglioconduttori - Cutting tool for conductors	-	

SITRACK 230V DALI
BINARIO PER MONTAGGIO A PLAFONE
TRACK FOR CEILING MOUNTING

ACCESSORI - ACCESSORIES

BINARIO ELETRIFICATO - TRACK









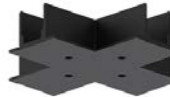

CODICE CODE	DESCRIZIONE DESCRIPTION	COLORE FINISH		
26101-DA	BINARIO TRIFASE - 3 CIRCUIT TRACK 1 m	BI	 	
26102-DA		NE		
26201-DA	BINARIO TRIFASE - 3 CIRCUIT TRACK 2 m	BI		
26202-DA		NE		
26301-DA	BINARIO TRIFASE - 3 CIRCUIT TRACK 3 m	BI		
26302-DA		NE		
990241-DA	Testata di alimentazione - contatto sinistro di messa a terra - Live end - Left earth contact	BI		
990242-DA		NE		
990251-DA	Testata di alimentazione - contatto destro di messa a terra - Live end - Right earth contact	BI		
990252-DA		NE		
990781-DA	Alimentatore centrale - Straight coupler for central feeding	BI		
990782-DA		NE		
990791-DA	Congiunzione a 90° - Contatto di terra esterno - 90° Coupler - Outside earth contact	BI		
990792-DA		NE		
990271-DA	Congiunzione a 90° - Contatto di terra interno - 90° Coupler - Inside earth contact	BI		
990272-DA		NE		
990289-DA	Congiunzione a T - Contatto di terra destro esterno - T coupler for surface - Outside left earth contact	BI		
990290-DA		NE		
990293-DA	Congiunzione a T - Contatto di terra sinistro esterno - T coupler for surface - Outside right earth contact	BI		
990294-DA		NE		
990291-DA	Congiunzione a T - Contatto di terra destro interno - T coupler for surface - Inside left earth contact	BI		
990292-DA		NE		
990301-DA	Congiunzione a T - Contatto di terra sinistro interno - T coupler for surface - Inside right earth contact	BI		
990302-DA		NE		
990311-DA	Congiunzione a X - X coupler for surface	BI		
990312-DA		NE		
990411-DA	Copertura per testata - Cover for end feed	BI		
990412-DA		NE		
990421-DA	Copertura per alimentatori centrale - Cover for central power supply	BI		
990422-DA		NE		
990431-DA	Copertura per congiunzione a 90° - Cover for 90° coupler	BI		
990432-DA		NE		

BINARIO ELETRIFICATO - TRACK



SITRACK 230V DALI
BINARIO PER MONTAGGIO AD INCASSO
TRACK FOR RECESSED MOUNTING

ACCESSORI - ACCESSORIES

CODICE CODE	DESCRIZIONE DESCRIPTION	COLORE FINISH	
990441-DA	Copertura per congiunzione a T - Cover for T coupler	BI	
990442-DA		NE	
990451-DA	Copertura per congiunzione a X - Cover for X coupler	BI	
990452-DA		NE	
7011-DA_BR	Kit sospensione a filo L.3 m per sospensione (ordinare anche staffa cod. 990751-990752) Wire suspension kit L.3 m for suspension, (you should order also clip cod. 990751-990752)	BI	
7011-DA-NE		NE	
990371-DA	Congiunzione rettilinea - Straight coupler	BI	
990372-DA		NE	
646759	Adattatore slim 6 conduttori - Slim adaptor 6 conductor	BI	
646758		NE	
990921-DA	Adattatore 6 conduttori - Adaptor 6 conductor	BI	
990922-DA		NE	
993381-DA	Testata di chiusura - End cap	BI	
993382-DA		NE	
990341-DA	Copribinario - Track cover	BI	
990342-DA		NE	
912900	Tronchese per taglioconduttori - Cutting tool for conductors	-	



BINARIO PLAFONE/SOSPENSIONE
CEILING MOUNTED/SUSPENDED TRACK



BINARIO SOSPENSIONE
SUSPENSION TRACK



BINARIO AD INCASSO
RECESSED TRACK

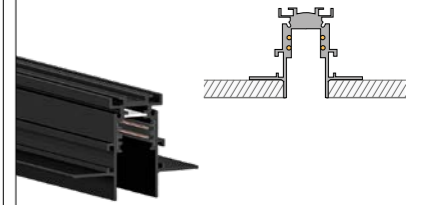

APPARECCHI PER BINARIO 48Vdc



ESTRUSO LINEARE CON OTTICA QUADRATA
ALUMINUM LINEAR STRUCTURE WITH SQUARE OPTIC UGR <19



ESTRUSO LINEARE CON LENTI TONDE
ALUMINUM LINEAR STRUCTURE WITH ROUND LENSES

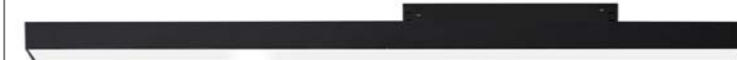

ESTRUSO LINEARE CON SCHERMO OPALE PER LINEA CONTINUA LUMINOSA
ALUMINUM LINEAR STRUCTURE WITH OPAL SCREEN FOR CONTINUOUS LIGHT LINE



SPOT CON ADATTATORE 48Vdc POLARIZZATO
SINGLE SPOT WITH POLARIZED ADAPTER



DOPPIO SPOT CON ADATTATORE 48Vdc POLARIZZATO
DOUBLE SPOT WITH POLARIZED ADAPTER



DROP SOSPENSIONE
CON ADATTATORE POLARIZZATO
DROP SUSPENSION WITH POLARIZED ADAPTER



BINARIO - TRACK 48Vdc system - click in click out



CODICE CODE	DESCRIZIONE DESCRIPTION	COLORE FINISH	
M-25101	BINARIO - TRACK 48Vdc ST1 1 m.	BI	
M-25102		NE	
M-25201	BINARIO - TRACK 48Vdc ST1 2 m.	BI	
M-25202		NE	
M-25301	BINARIO - TRACK 48Vdc ST1 3 m.	BI	
M-25302		NE	
M-99057	TESTATA CHIUSURA - END CAP ST1	BI	
M-99058		NE	
M-99059	TESTATA DI CHIUSURA CON FORO - END CAP ST1 WITH HOLE FOR CABLE ST1	BI	
M-99060		NE	
M-99061	STAFFA FISSAGGIO MECCANICO PER SOSPENSIONE - MECHANICAL FIXING BRACKET FOR SUSPENSION	BI	
M-99062		NE	
M-99063	STAFFA PER SOSPENSIONE CON TENDITORE - BRACKET FOR SUSPENSION WITH GRIPPER (COMPLETO DI FUNE - COMPLETO DI FUNE)	BI	
M-99064		NE	
M-25101H	BINARIO - TRACK 48Vdc ST2 1 m.	BI	
M-25102H		NE	
M-25201H	BINARIO - TRACK 48Vdc ST2 2 m.	BI	
M-25202H		NE	
M-25301H	BINARIO - TRACK 48Vdc ST2 3 m.	BI	
M-25302H		NE	
M-99051	TESTATA CHIUSURA - END CAP ST2	BI	
M-99052		NE	
M-99053	TESTATA DI CHIUSURA CON FORO ST2 - END CAP ST2 WITH HOLE FOR CABLE	BI	
M-99054		NE	
M-99055	STAFFA FISSAGGIO MECCANICO PER SOSPENSIONE ST2 - MECHANICAL FIXING BRACKET ST2 FOR SUSPENSION	ALS	
M-99056	STAFFA PER SOSPENSIONE CON TENDITORE ST2 - BRACKET FOR SUSPENSION ST2 WITH GRIPPER (COMPLETO DI FUNE - COMPLETO DI FUNE)	ALS	

BINARIO 48Vdc
BINARIO PLAFONE/SOSPENSIONE
CEILING MOUNTED/SUSPENDED TRACK



BINARIO 48Vdc
BINARIO SOSPENSIONE
SUSPENSION TRACK



BINARIO - TRACK 48Vdc system - click in click out

CODICE CODE	DESCRIZIONE DESCRIPTION	COLORE FINISH	LISTINO PRICELIST	
M-26102	BINARIO DA INCASSO ST5 - RECESSED TRACK ST5 1 m.	NE		
M-26202	BINARIO DA INCASSO ST5 - RECESSED TRACK ST5 2 m.	NE		
M-26302	BINARIO DA INCASSO ST5 - RECESSED TRACK ST5 3 m.	NE		
M-99052	TESTATA DI CHIUSURA ST2 - ST5 - END CAP ST2 - ST5	NE		
M-99076	CLIP CON TENDITORE AUTOMATICO - CLAMP WITH AUTOMATIC GRIPPER	ALS		
M-99077	STAFFA, BARRA FILETTATA M6 E DADO PER FISSAGGIO A SOFFITTO PER SOSPENSIONE BRACKET, M6 THREADED BAR AND NUT FOR CEILING MOUNTING	ALS		
M-99075	STAFFA DI RINFORZO PER GIUNTO DIRETTO - REINFORCED BRACKET FOR DIRECT JOINTING	ALS		
M-99039	CLIP PER FISSAGGIO RAPIDO DEL BINARIO - TRACK FAST FIXING CLAMP	ACCIAIO - STEEL		
M-99040	TESTATA DI ALIMENTAZIONE PER BINARIO ST1 - ST2 - ST5 - END FEED FOR ST1 - ST2 - ST5 TRACK	BI		
M-99041		NE		
M-99044	GIUNTO PASSANTE PER BINARIO ST1 - ST2 - ST5 - JOIN TING CONNECTOR FOR ST1 - ST2 - ST5 TRACK	BI		
M-99045		NE		
M-99046	GIUNTO A L - L JOINT	BI		
M-99047		NE		
M-99048	COPERTURA PER GIUNTO A L PER BINARIO ST2 - COVER FOR L JOINT FOR ST2 TRACK	BI		
M-99049		NE		
M-99050	STAFFA A L PER GIUNTI ANGOLARI - L BRACKET FOR ANGLES	ACCIAIO		

BINARIO 48Vdc
BINARIO INCASSO
RECESSED TRACK



ACCESSORI PER CONNESSIONE A BINARIO
ACCESSORIES FOR CONNECTION ON TRACK
BINARIO 48Vdc

BINARIO - TRACK 48Vdc system - click in click out



CODICE CODE	DESCRIZIONE DESCRIPTION	FASCIO BEAM	COLORE FINISH	
M-6005-LBC/LBN	10,2W 1000Lm 48Vdc - L.567mm ESTRUSO LINEARE OTTICA QUADRA - ALUMINUM LINEAR STRUCTURE WITH SQUARE OPTIC	60°	NE	<p>ESTRUSO LINEARE CON OTTICA QUADRATA ALUMINUM LINEAR STRUCTURE WITH SQUARE OPTIC</p>
M-6007-LBC/LBN	18,2W 1900Lm 48Vdc - L.1128mm ESTRUSO LINEARE OTTICA QUADRA - ALUMINUM LINEAR STRUCTURE WITH SQUARE OPTIC	60°	NE	<p>IP 20 UGR<19</p> <p>a richiesta on request </p>
M-6001-LBC/LBN	10,2W 1100Lm 48Vdc - L.567mm ESTRUSO LINEARE OTTICA TONDA - ALUMINUM LINEAR STRUCTURE WITH ROUND LENSES	60°	NE	<p>ESTRUSO LINEARE CON LENTI TONDE LINEAR STRUCTURE WITH ROUND LENSES</p>
M-6003-LBC/LBN	18,2W 1900Lm 48Vdc - L.1128mm ESTRUSO LINEARE OTTICA TONDA - ALUMINUM LINEAR STRUCTURE WITH ROUND LENSES	60°	NE	<p>IP 20 UGR<19</p> <p>a richiesta on request </p>
M-6002-LBC/LBN	ESTRUSO LINEARE SCHERMO OPALE PER LINEA CONTINUA 11,9W 1000Lm 48Vdc - L.567mm ALUMINUM LINEAR STRUCTURE WITH OPAL SCREEN FOR CONTINUOUS LIGHT LINE	120°	NE	<p>ESTRUSO LINEARE CON SCHERMO OPALE LINEAR STRUCTURE WITH OPAL SCREEN</p>
M-6004-LBC/LBN	23,8W 2100Lm 48Vdc - L.1128mm ESTRUSO LINEARE SCHERMO OPALE PER LINEA CONTINUA ALUMINUM LINEAR STRUCTURE WITH OPAL SCREEN FOR CONTINUOUS LIGHT LINE	120°	NE	<p>IP 20 UGR<19</p> <p>a richiesta on request </p>
M-6006-LBC/LBN	19,8W 2600Lm 48Vdc - L.1408mm ESTRUSO LINEARE SCHERMO OPALE PER LINEA CONTINUA ALUMINUM LINEAR STRUCTURE WITH OPAL SCREEN FOR CONTINUOUS LIGHT LINE	120°	NE	<p>IP 20 UGR<19</p> <p>a richiesta on request </p>
M-67383-LBC/LBN20	13W 1400Lm 48Vdc SPOT SINGOLO CON ADATTATORE BINARIO 48Vdc - SINGLE SPOT WITH ADAPTER TRACK 48Vdc	20°	BI	<p>SPOT SINGOLO CON ADATTATORE SINGLE SPOT WITH ADAPTER</p>
M-67384-LBN/LBN20			NE	
M-67386-LBC/LBN20	26W 2800Lm 48Vdc SPOT DOPPIO CON ADATTATORE BINARIO 48Vdc - DOUBLE SPOT WITH ADAPTER TRACK 48Vdc	20°	BI	<p>SPOT DOPPIO CON ADATTATORE DOUBLE SPOT WITH ADAPTER</p>
M-67387-LBC/LBN20			NE	
M-D2210-LBC/LBN-S	4,5W 260Lm 48Vdc DROP 30S XS CON ADATTATORE BINARIO 48Vdc - DROP 30S XS WITH ADAPTER TRACK 48Vdc	45°	BR	<p>DROP 30S XS</p>
M-D2211-LBC/LBN-S			NE	

**PARETE PLAFONE E SOSPENSIONI
WALL-SURFACE AND SUSPENSION**



NEW

SWING
5,5W - 510Lm

PERFORMANCE



PLANA

foro 115x110mm - 20-40-60W - 2300-4600-6900Lm

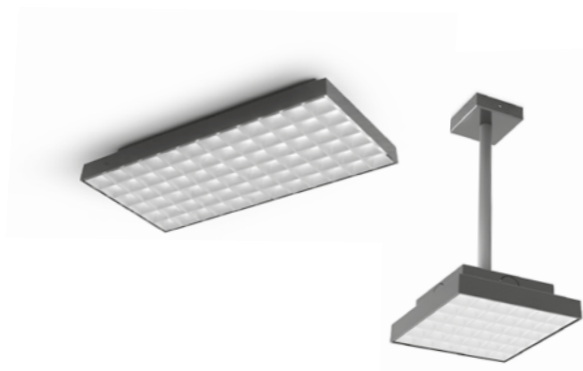

BIG NEW

da 16 a 190W - da 1500 a 19000Lm



LINE

26/43W - 2400/4000Lm



LUNGHEZZE - LENGTHS	UGR	DALI
840 mm 1400 mm	UGR <19	a richiesta on request DALI



LINEAR SYSTEM **STAND-ALONE**

SINDI

da 10 a 13,5W - da 450 a 1200Lm

ESSENTIAL



DROP

5,5W - 510Lm



NEW

RULED LINEAR IP SOSPENSIONE

14/27/40W - 1470/2950/4400Lm

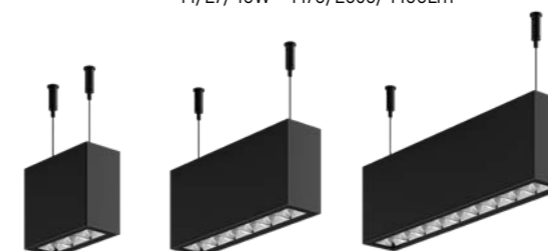

QUADRANT

da 13,8 a 51,2W - da 750 a 3000Lm

DESIGN



STARGATE

da 51 a 270W - da 4500 a 20000Lm



ELISEO

da 16,5 a 76,4W - da 1200 a 6400Lm

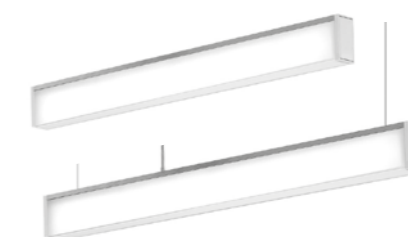

PARETE PLAFONE E SOSPENSIONI - WALL-SURFACE AND SUSPENSION



CODICE CODE	DESCRIZIONE DESCRIPTION	FASCIO BEAM	COLORE FINISH
4580-LBC/LBN	PLANA 120 20W 2300Lm 500mA	30°	NE
4585-LBC/LBN	PLANA 240 40W 4600Lm 500mA	30°	NE
4590-LBC/LBN	PLANA 360 60W 6900Lm 500mA	30°	NE
4575	PLANA 120 153x153mm - Kit incasso cornice rasamento - Flush recessed frame kit - TRIMLESS	-	-
4576	PLANA 240 153x270mm - Kit incasso cornice rasamento - Flush recessed frame kit - TRIMLESS	-	-
4577	PLANA 360 153x390mm - Kit incasso cornice rasamento - Flush recessed frame kit - TRIMLESS	-	-
4578	Kit sospensione - Suspension kit - 60x60mm rosone - canopy	-	-
3860-LBC/LBN-75	RULED LINEAR IP54 SOSPENSIONE 3 LED - L. 132mm - 14W 1470Lm 500mA LUCE DIRETTA - LIGHT DIRECT	75°	NE
3865-LBC/LBN-75	RULED LINEAR IP54 SOSPENSIONE 6 LED - L. 247mm - 27W 2950Lm 500mA LUCE DIRETTA - LIGHT DIRECT	75°	NE
3875-LBC/LBN-75	RULED LINEAR IP54 SOSPENSIONE 3 + 6 LED - L. 247mm - 40W 4400Lm 500mA LUCE DIRETTA/INDIRETTA - LIGHT DIRECT/INDIRECT	75°	NE
3870-LBC/LBN-75	RULED LINEAR IP54 SOSPENSIONE 9 LED - L. 362mm - 40W 4400Lm 500mA LUCE DIRETTA - LIGHT DIRECT	75°	NE
3880-LBC/LBN-75	RULED LINEAR IP54 SOSPENSIONE 6 + 9 LED - L. 362mm - 67W 7380Lm 500mA LUCE DIRETTA/INDIRETTA - LIGHT DIRECT/INDIRECT	75°	NE

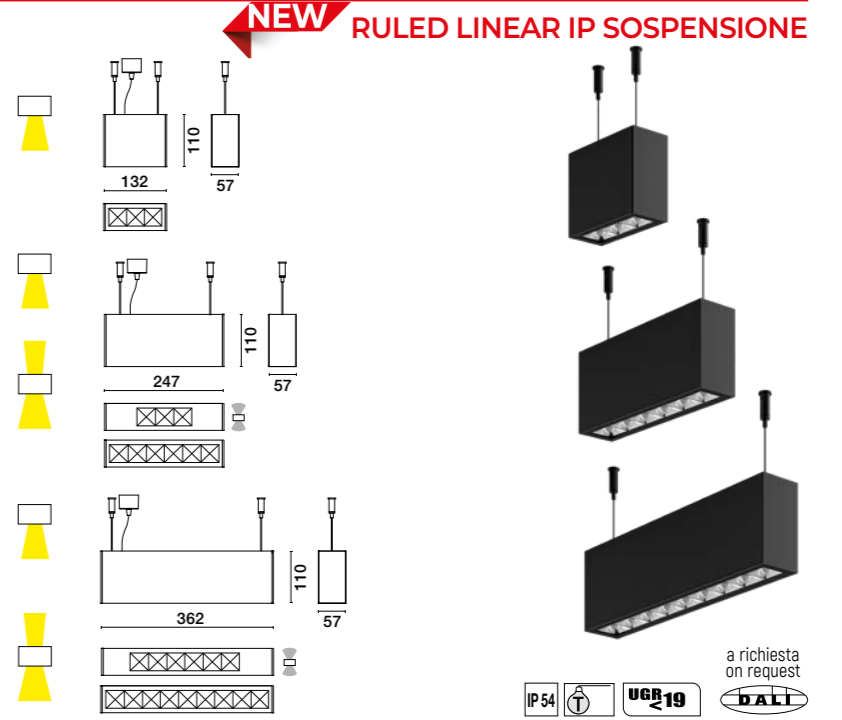
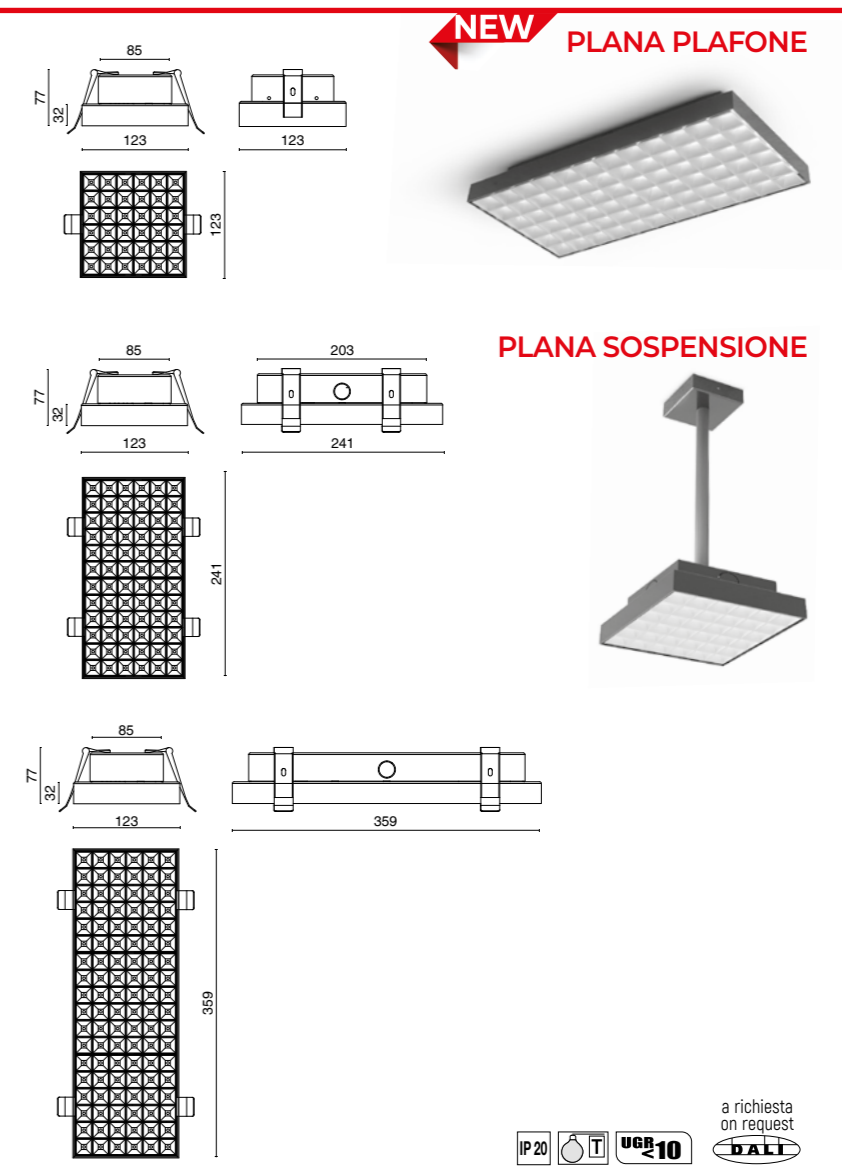

PARETE PLAFONE E SOSPENSIONI - WALL-SURFACE AND SUSPENSION



CODICE CODE	DESCRIZIONE DESCRIPTION	COLORE FINISH		
2868-LBC/LBN-P	SINDI 60 PLAFONE 8W 360Lm 200mA IP54	BR		SINDI 60 P
2869-LBC/LBN-P		NE		
2870-LBC/LBN-P		GR		
2860-LBC/LBN-P	SINDI 100 PLAFONE 13,5W 1200Lm 350mA IP54	BR		SINDI 100 P
2861-LBC/LBN-P		NE		
2862-LBC/LBN-P		GR		
2880-LBC/LBN-P	SWING 10 PLAFONE 20W 1900Lm 500mA	BR		SWING 10 P
2881-LBC/LBN-P		NE		
2885-LBC/LBN-P	SWING 13 PLAFONE 35W 3500Lm 900mA	BR		SWING 13 P
2886-LBC/LBN-P		NE		
2887-LBC/LBN-P		GR		

PARETE PLAFONE E SOSPENSIONI - WALL-SURFACE AND SUSPENSION



CODICE CODE	DESCRIZIONE DESCRIPTION	FASCIO BEAM	COLORE FINISH		
D2210-LBC/LBN	DROP 30 XS 4,5W 270Lm 350mA - ø 40mm	45°	BR		
D2211-LBC/LBN			NE		
D2212-LBC/LBN			GR		
D2216-MLBC/MLBN-25/40	DROP 30 M 8,3W 800Lm 200mA - ø 60mm	45°	BR		
D2217-MLBC/MLBN-25/40			NE		
D2218-MLBC/MLBN-25/40			GR		
D2234-LBC/LBN-15/25/40	DROP 30 XL 20W 2100Lm 500mA - ø 90mm	15 - 25 - 40°	BR		
D2235-LBC/LBN-15/25/40			NE		
D2236-LBC/LBN-15/25/40			GR		
D2213-LBC/LBN	DROP 60 XS 4,5W 270Lm 350mA - ø 40mm	45°	BR		
D2214-LBC/LBN			NE		
D2215-LBC/LBN			GR		
D2225-MLBC/MLBN25/40	DROP 60 M 8,3W 800Lm 200mA - ø 60mm	25 - 40°	BR		
D2226-MLBC/MLBN25/40			NE		
D2227-MLBC/MLBN25/40			GR		
D2237-LBC/LBN-15/25/40	DROP 60 XL 20W 2100Lm 500mA - ø 90mm	15 - 25 - 40°	BR		
D2238-LBC/LBN-15/25/40			NE		
D2239-LBC/LBN-15/25/40			GR		
D2210-LBC/LBN-S	DROP 30S XS 4,5W 270Lm 350mA - ø 40mm	45°	BR		
D2211-LBC/LBN-S			NE		
D2212-LBC/LBN-S			GR		
D2216-MLBC/MLBN25/40S	DROP 30S M 8,3W 800Lm 200mA - ø 60mm	25 - 40°	BR		
D2217-MLBC/MLBN25/40S			NE		
D2218-MLBC/MLBN25/40S			GR		
D2234-LBC/LBN-15/25/40S	DROP 30S XL 20W 2100Lm 500mA - ø 90mm	15 - 25 - 40°	BR		
D2235-LBC/LBN-15/25/40S			NE		
D2236-LBC/LBN-15/25/40S			GR		
D2213-LBC/LBN-S	DROP 60S XS 4,5W 270Lm 350mA - ø 40mm	45°	BR		
D2214-LBC/LBN-S			NE		
D2215-LBC/LBN-S			GR		
D2225-MLBC/MLBN25/40S	DROP 60S M 8,3W 800Lm 200mA - ø 60mm	25 - 40°	BR		
D2226-MLBC/MLBN25/40S			NE		
D2227-MLBC/MLBN25/40S			GR		
D2237-LBC/LBN-15/25/40S	DROP 60S XL 20W 2100Lm 500mA - ø 90mm	15 - 25 - 40°	BR		
D2238-LBC/LBN-15/25/40S			NE		
D2239-LBC/LBN-15/25/40S			GR		

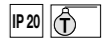
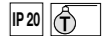
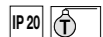
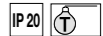

PARETE PLAFONE E SOSPENSIONI - WALL-SURFACE AND SUSPENSION



CODICE CODE	DESCRIZIONE DESCRIPTION	FASCIO BEAM	COLORE FINISH		
5401-LBC/LBN-30/60	AURORA XS 41W 4100Lm 1050mA	30 - 60°	BR		
5402-LBC/LBN-30/60			NE		
5403-LBC/LBN-30/60			GR		
5404-LBC/LBN	AURORA XL 41W 4300Lm 1050mA	90°	BR		
5405-LBC/LBN			NE		
5406-LBC/LBN			GR		
5407-LBC/LBN	AURORA XL PLUS 47W 4600Lm 1200mA	90°	BR		
5408-LBC/LBN			NE		
5409-LBC/LBN			GR		
QDR40-P-LBC/LBN	QUADRANT 13,8W 750Lm 350mA 400x400mm - PARETE/PLAFONE	-	ALS		
QDR40-LBC/LBN	QUADRANT 13,8W 750Lm 350mA 400x400mm - SOSPENSIONE	-	ALS		
QDR60-LBC/LBI-P	QUADRANT 51,2W 3000Lm 350mA 600x600mm - PARETE/PLAFONE	-	ALS		
QDR60-LBC/LBI	QUADRANT 51,2W 3000Lm 350mA 600x600mm - SOSPENSIONE	-	ALS		
QDR27-P-LBC/LBN	QUADRANT 29,2W 2000Lm 350mA 600x270mm - PARETE/PLAFONE	-	ALS		
QDR27-LBC/LBN	QUADRANT 29,2W 2000Lm 350mA 600x270mm - SOSPENSIONE	-	ALS		

IP 20 a richiesta - on request **FOOD** **BALI**

IP 20 a richiesta - on request **FOOD** **BALI**

IP 20

PARETE PLAFONE E SOSPENSIONI - WALL-SURFACE AND SUSPENSION



CODICE CODE	DESCRIZIONE DESCRIPTION	FASCIO BEAM	COLORE FINISH
5565N-LBC/LBN	BIG NEW 440 38W 2200Lm 900mA IP40	-	BR
5566N-LBC/LBN			NE
5567N-LBC/LBN			GR
Versione schermo - version screen UGR>19 - aggiungere al prezzo di listino - to be added to the list price		-	-
5535N-LBC/LBN	BIG NEW 550 55W 4100Lm 700mA IP40	-	BR
5536N-LBC/LBN			NE
5537N-LBC/LBN			GR
Versione schermo - version screen UGR>19 - aggiungere al prezzo di listino - to be added to the list price		-	-
5555N-LBC/LBN	BIG NEW 750 84W 6800Lm 800mA IP40	-	BR
5556N-LBC/LBN			NE
5557N-LBC/LBN			GR
Versione schermo - version screen UGR>19 - aggiungere al prezzo di listino - to be added to the list price		-	-
5575N-LBC/LBN	BIG NEW 1030 191,5W 19200Lm 24Vdc IP40	-	BR
5576N-LBC/LBN			NE
5577N-LBC/LBN			GR
Versione schermo - version screen UGR>19 - aggiungere al prezzo di listino - to be added to the list price		-	-
980131	ACCESSORI - ACCESSORIES Kit sospensione universale - Universal suspension Kit	-	BR
980132			NE
980133			GR

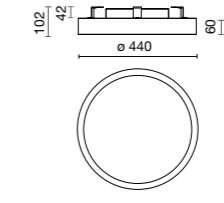

BIG NEW

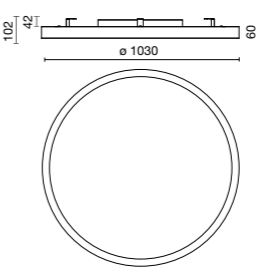
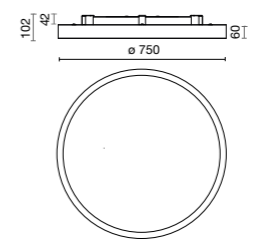
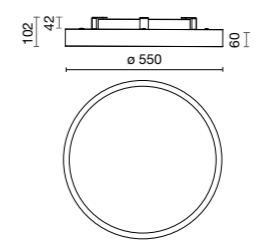

Per SOSPENSIONE ordinare il Kit
For SUSPENSION order a Kit

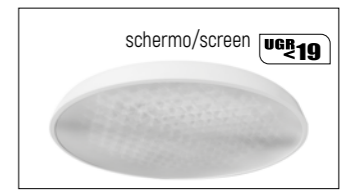

A richiesta - on request
Cavo di alimentazione in tessuto bianco o nero
White or black fabric power cable

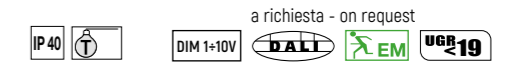

PARETE PLAFONE E SOSPENSIONI - WALL-SURFACE AND SUSPENSION



CODICE CODE	DESCRIZIONE DESCRIPTION	FASCIO BEAM	COLORE FINISH		
5600-LBC2/LBN2	STARGATE 550 ECO 51W 4500Lm 500mA IP40 - DIRETTO+INDIRETTO - DIRECT+INDIRECT	-	BR		
5601-LBC2/LBN2		NE			
5602-LBC2/LBN2		GR			
5605-LBC2/LBN2	STARGATE 750 ECO 70W 6600Lm 700mA IP40 - DIRETTO+INDIRETTO - DIRECT+INDIRECT	-	BR		
5606-LBC2/LBN2		NE			
5607-LBC2/LBN2		GR			
5610-LBC3/LBN3	STARGATE 950 ECO 92W 8100Lm 650mA IP40 - DIRETTO+INDIRETTO - DIRECT+INDIRECT	-	BR		
5611-LBC3/LBN3		NE			
5612-LBC3/LBN3		GR			
5615-LBC4/LBN4	STARGATE 1250 ECO 112W 10000Lm 500mA IP40 - DIRETTO+INDIRETTO - DIRECT+INDIRECT	-	BR		
5616-LBC4/LBN4		NE			
5617-LBC4/LBN4		GR			
5620-LBC4/LBN4	STARGATE 1250 ECO 58W 4800Lm 500mA IP40 - DIRETTO - DIRECT	-	BR		
5621-LBC4/LBN4		NE			
5622-LBC4/LBN4		GR			
5630-LBC/LBN	STARGATE 2000 178W 9500+4700Lm 220-240V 24V IP40 - DIRETTO+INDIRETTO - DIRECT+INDIRECT	-	BR		
5631-LBC/LBN		NE			
5632-LBC/LBN		GR			
5625-LBC/LBN	STARGATE 2000 120W 9500Lm 220-240V 24V IP40 IP40 - DIRETTO - DIRECT	-	BR		
5626-LBC/LBN		NE			
5627-LBC/LBN		GR			
5640-LBC/LBN	STARGATE 3000 270W 14000+7000Lm 220-240V 24V IP40 - DIRETTO+INDIRETTO - DIRECT+INDIRECT	-	BR		
5641-LBC/LBN		NE			
5642-LBC/LBN		GR			
5635-LBC/LBN	STARGATE 3000 180W 14000Lm 220-240V 24V IP40 IP40 - DIRETTO - DIRECT	-	BR		
5636-LBC/LBN		NE			
5637-LBC/LBN		GR			

a richiesta on request
EM

a richiesta on request
EM

a richiesta - on request
IP 40
DIM 1+10V/PUSH
DALI

LINE

LINEAR SYSTEM STAND-ALONE

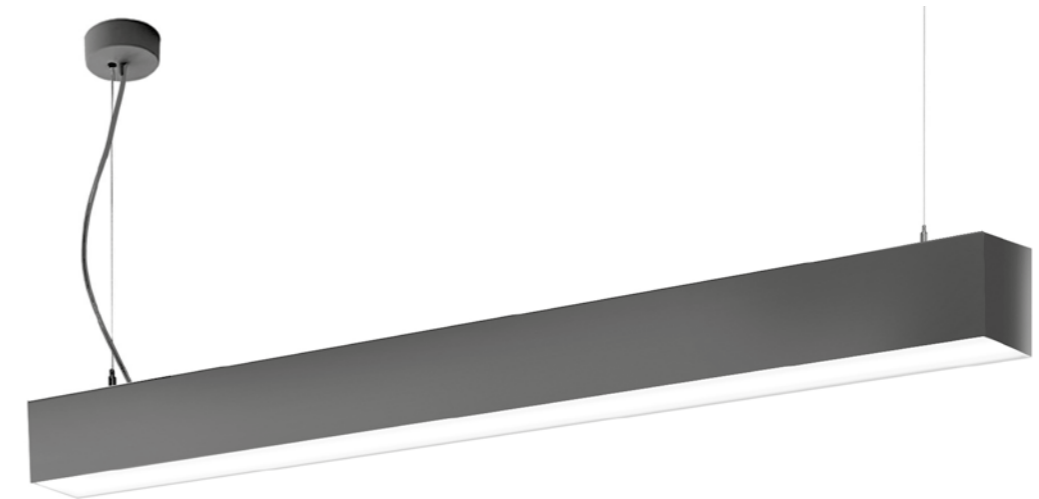

CODICE CODE	DESCRIZIONE DESCRIPTION	FASCIO BEAM	COLORE FINISH	
3350-KT-LBC/LBN-D9	LINE L.840mm 26W 2400Lm	45°	BI	<p>L = 840mm 1400mm</p>
3351-KT-LBC/LBN-D9			NE	
3350-KT-LBC/LBN-D14	LINE L.1400mm 43W 4000Lm	45°	BI	
3351-KT-LBC/LBN-D14			NE	
3350-KT-LBC/LBN-DE9	LINE L.840mm 26W 2400Lm - DIRETTO - 9W 800Lm INDIRETTO - DIR. - INDIR.	DIRETTO-INDIRETTO 45°	BI	
3351-KT-LBC/LBN-DE9			NE	
3350-KT-LBC/LBN-DE14	LINE L.1400mm 43W 4000Lm - DIRETTO - 14W 1330Lm INDIRETTO - DIR. - INDIR.	DIRETTO-INDIRETTO 15 - 25 - 40°	BI	
3351-KT-LBC/LBN-DE14			NE	
699907	ACCESSORI - ACCESSORIES		BR	
699908	Rosone per sospensione - Canopy for suspension		NE	

LINE

PARETE PLAFONE E SOSPENSIONI - WALL-SURFACE AND SUSPENSION



ELISEO

CODICE CODE	DESCRIZIONE DESCRIPTION	COLORE FINISH
3424-830/840	ELISEO PARETE L. 602mm 16,5W 1300Lm 500mA	BR
3425-830/840	ELISEO PARETE L. 902mm 24,7W 2000Lm 500mA	BR
3426-830/840	ELISEO PARETE L. 1202mm 33W 2600Lm 500mA	BR
3427-830/840	ELISEO PARETE L. 1502mm 40,2W 3300Lm 500mA	BR
3429-830/840	ELISEO PARETE L. 602mm 16,5W 1300Lm 500mA SCHERMO FRONTALE ALLUMINIO - FRONTAL ALUMINIUM SCREEN	BR
3430-830/840	ELISEO PARETE L. 902mm 24,7W 2000Lm 500mA SCHERMO FRONTALE ALLUMINIO - FRONTAL ALUMINIUM SCREEN	BR
3431-830/840	ELISEO PARETE L. 1202mm 33W 2600Lm 500mA SCHERMO FRONTALE ALLUMINIO - FRONTAL ALUMINIUM SCREEN	BR
3432-830/840	ELISEO PARETE L. 1502mm 40,2W 3300Lm 500mA SCHERMO FRONTALE ALLUMINIO - FRONTAL ALUMINIUM SCREEN	BR
3409-830/840	ELISEO SOSPENSIONE L. 602mm 16,5W 1300Lm 500mA SINGOLO - SINGLE	BR
3410-830/840	ELISEO SOSPENSIONE L. 902mm 16,5W 1300Lm 500mA SINGOLO - SINGLE	BR
3411-830/840	ELISEO SOSPENSIONE L. 1202mm 16,5W 1300Lm 500mA SINGOLO - SINGLE	BR
3412-830/840	ELISEO SOSPENSIONE L. 150mm 16,5W 1300Lm 500mA SINGOLO - SINGLE	BR
3414-830/840	ELISEO SOSPENSIONE L. 602 16,5W 1300Lm 500mA DOPPIO VERTICALE - VERTICAL DOUBLE DIFFUSER	BR
3415-830/840	ELISEO SOSPENSIONE L. 902 16,5W 1300Lm 500mA DOPPIO VERTICALE - VERTICAL DOUBLE DIFFUSER	BR
3416-830/840	ELISEO SOSPENSIONE L. 1202mm 16,5W 1300Lm 500mA DOPPIO VERTICALE - VERTICAL DOUBLE DIFFUSER	BR
3417-830/840	ELISEO SOSPENSIONE L. 1502mm 16,5W 1300Lm 500mA DOPPIO VERTICALE - VERTICAL DOUBLE DIFFUSER	BR
3419-830/840	ELISEO SOSPENSIONE L. 602mm 16,5W 1300Lm 500mA DOPPIO ORIZZONTALE - HORIZONTAL DOUBLE DIFFUSER	BR
3420-830/840	ELISEO SOSPENSIONE L. 902mm 16,5W 1300Lm 500mA DOPPIO ORIZZONTALE - HORIZONTAL DOUBLE DIFFUSER	BR
3421-830/840	ELISEO SOSPENSIONE L. 1202mm 16,5W 1300Lm 500mA DOPPIO ORIZZONTALE - HORIZONTAL DOUBLE DIFFUSER	BR
3422-830/840	ELISEO SOSPENSIONE L. 1502mm 16,5W 1300Lm 500mA DOPPIO ORIZZONTALE - HORIZONTAL DOUBLE DIFFUSER	BR

L = ø 602mm
ø 902mm
ø 1202mm
ø 1502mm

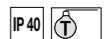
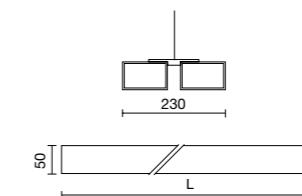
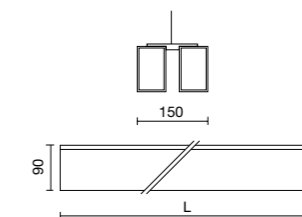
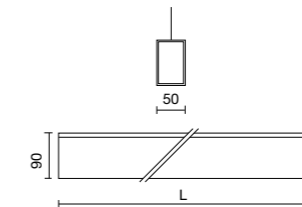
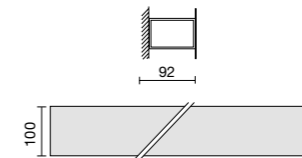
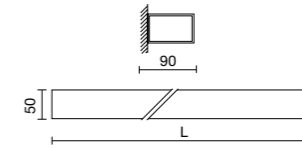

a richiesta on request



SD-HIGHBAY

da 93W a 234W - da 11000 a 28000Lm



ROSS

47,5W - 7000Lm



FUNZIONALI - GRANDI AMBIENTI - FUNCTIONAL LIGHTING - INDUSTRIAL USE



CODICE CODE	DESCRIZIONE DESCRIPTION	FASCIO BEAM	COLORE FINISH		
E6003-LBN-P	SD-HIGHBAY PARETE/PLAFONE 92W 11400Lm 600mA	50°	GRA		
E6007-LBN-P		80°	GRA		
E6009-LBN-P		ELLITTICO	GRA		
E6001-LBN-P	SD-HIGHBAY PARETE/PLAFONE 164W 18000Lm 1050mA	50°	GRA		
E6006-LBN-P		80°	GRA		
E6011-LBN-P		ELLITTICO	GRA		
E6000-LBN-P	SD-HIGHBAY PARETE/PLAFONE 170W 28000Lm 1050mA	50°	GRA		
E6005-LBN-P		80°	GRA		
E6010-LBN-P		ELLITTICO	GRA		
E6003-LBN	SD-HIGHBAY SOSPENSIONE 92W 11400Lm 600mA	50°	GRA		
E6007-LBN		8°	GRA		
E6009-LBN		ELLITTICO	GRA		
E6001-LBN	SD-HIGHBAY SOSPENSIONE 164W 18000Lm 1050mA	50°	GRA		
E6006-LBN		80°	GRA		
E6011-LBN		ELLITTICO	GRA		
E6000-LBN	SD-HIGHBAY SOSPENSIONE 170W 28000Lm 1050mA	50°	GRA		
E6005-LBN		80°	GRA		
E6010-LBN		ELLITTICO	GRA		
E6002	ACCESSORI - ACCESSORIES Paralume - Shield	-	GRA		

SD-HIGHBAY

a richiesta on request
BALI

FUNZIONALI - GRANDI AMBIENTI - FUNCTIONAL LIGHTING - INDUSTRIAL USE



ROSS

CODICE CODE	DESCRIZIONE DESCRIPTION	FASCIO BEAM	COLORE FINISH		
4465-LBC/LBN	ROSS PARETE 47,5W 7100Lm 500mA - fascio/beam FS	FS	BR		
4466-LBC/LBN			NE		
4467-LBC/LBN	ROSS PARETE 47,5W 7100Lm 500mA - fascio/beam FL	FL	BR		
4468-LBC/LBN			NE		
4469-LBC/LBN	ROSS PARETE 47,5W 7100Lm 500mA - fascio/beam AS	AS	BR		
4470-LBC/LBN			NE		
4471-LBC/LBN	ROSS PARETE 47,5W 7100Lm 500mA - fascio/beam BAS	BAS	BR		
4472-LBC/LBN			NE		
4475-LBC/LBN	ROSS SOSPENSIONE 47,5W 7100Lm 500mA - fascio/beam FS	FS	BR		
4476-LBC/LBN			NE		
4477-LBC/LBN	ROSS SOSPENSIONE 47,5W 7100Lm 500mA - fascio/beam FL	FL	BR		
4478-LBC/LBN			NE		
4479-LBC/LBN	ROSS SOSPENSIONE 47,5W 7100Lm 500mA - fascio/beam AS	AS	BR		
4480-LBC/LBN			NE		
4481-LBC/LBN	ROSS SOSPENSIONE 47,5W 7100Lm 500mA - fascio/beam BAS	BAS	BR		
4482-LBC/LBN			NE		

PANEL
Elemento fonoassorbente ancorato a parete o sospeso a plafone.
Acoustic panel wall or suspension.

SONUS PANEL

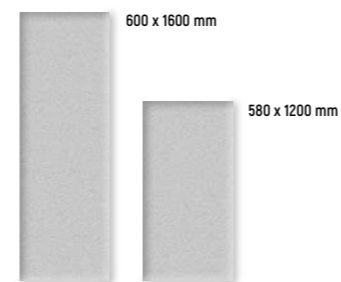

REFLECT
Elemento fonoassorbente retroilluminato a plafone e parete.
Acoustic panel with back light wall or suspension.

SONUS REFLECT

23W 1400Lm
36W 2300Lm
44W 2800Lm

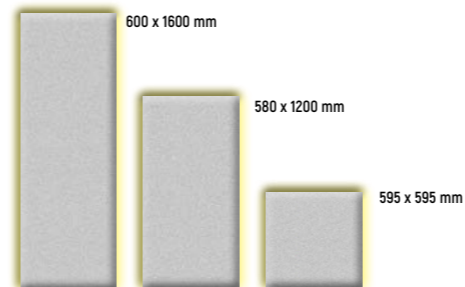

QDR60
Elemento fonoassorbente quadrato da incasso, predisposto per contenere un corpo illuminante.
Acoustic square panel for recessed installation suitable for lighting integration.

SONUS QDR60

17,5W 1500Lm

RULED T13 42,5W 3400Lm
SWING 13 35/52W 3400/5800Lm

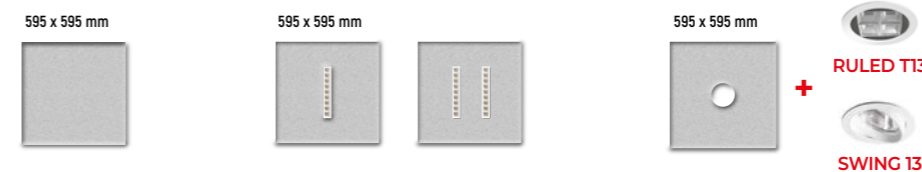

SQUARE
Elemento fonoassorbente rettangolare a plafone o sospensione, con corpo illuminante.
Acoustic rectangular panel with integrated lighting for ceiling and suspension installation.

SONUS SQUARE

1 LED = 17,5W 1500Lm
2 LED = 35W 2900Lm
3 LED = 53W 4400Lm
6 LED = 106W 8800Lm
4 LED = 70W 5900Lm
8 LED = 140W 11800Lm



ROUND
Elemento fonoassorbente tondo a sospensione, con corpo illuminante.
Acoustic round panel with integrated lighting for suspension installation.

SONUS ROUND

31W 3300Lm

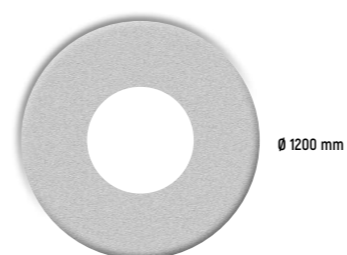

CIRCLE
Corpo illuminante circolare a sospensione con inserto fonoassorbente.
Circular lighting fitting with acoustic panel integrated.

SONUS CIRCLE

da 46 a 112W - da 4000 a 10000Lm

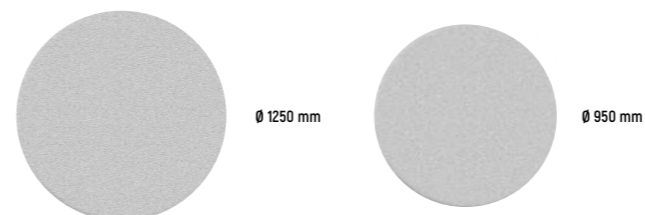
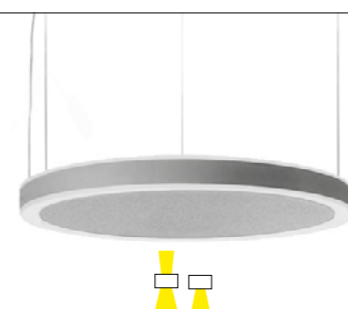

COLORI DISPONIBILI



COLORI DISPONIBILI - FINISHES AVAILABLE

CORPO - BODY:
 BIANCO - WHITE NERO - BLACK GRIGIO - GREY

PANNELLO - ACOUSTIC PANEL:
 BG BIANCO GHIACCIO - ICE WHITE

CODICE CODE	DESCRIZIONE DESCRIPTION	FASCIO BEAM	COLORE FINISH	
PAN12Z-XX	SONUS PANEL pannello cieco - Close panel - 580x1200mm Quantità minima per colore pz 4 - Minimum qty for each finish: 4	-	8 COLORI	<p>SONUS PANEL</p>
PAN16Z-XX	SONUS PANEL pannello cieco - Close panel - 600x1600mm Quantità minima per colore pz 2 - Minimum qty for each finish: 2	-	8 COLORI	
980119	Kit di fissaggio a parete - Kit for wall installation	-	-	
980129	Kit di fissaggio a sospensione per pannello - Kit for suspension - 580x1200mm	-	-	
980130	Kit di fissaggio a sospensione per pannello - Kit for suspension - 600x1600mm	-	-	
RFL60P-Z1BC/Z1BN-XX	SONUS REFLECT 23W 1400Lm 24Vdc - 595x595mm Quantità minima per colore pz 8 - Minimum qty for each finish: 8	-	8 COLORI	<p>SONUS REFLECT</p>
RFL12P-Z1BC/Z1BN-XX	SONUS REFLECT 36W 2200Lm 24Vdc - 580x1200mm Quantità minima per colore pz 4 - Minimum qty for each finish: 4	-	8 COLORI	
RFL16P-Z1BC/Z1BN-XX	SONUS REFLECT 44W 2800Lm 24Vdc - 600x1600mm Quantità minima per colore pz 2 - Minimum qty for each finish: 2	-	8 COLORI	
168	Rosone verticale - Vertical canopy - H. 110 x 42mm	-	BR	
169			NE	
165	Rosone orizzontale - Horizontal canopy - H. 45 x 130mm	-	BR	
166			NE	
980129	Kit di fissaggio a sospensione per pannello - Kit for suspension - 580x1200mm	-	-	

SONUSLINE PANNELLI FONOASSORBENTI CON CORPI ILLUMINANTI - ACOUSTIC PANEL WITH LIGHTING FITTINGS INTEGRATED



CODICE CODE	DESCRIZIONE DESCRIPTION	FASCIO BEAM	COLORE FINISH		
QDR60Z-XX	SONUS QDR60 Pannello cieco - Close panel 595x595mm - INCASSO - RECESSED PER CONTROSOFFITTO - FOR FALSE CEILING Quantità minima per colore pz 8 - Minimum qty for each finish: 8	-	8 COLORI		SONUS QDR60
QDR60I-B1BC/B1BN-XX	SONUS QDR60 1 MODULO LED 17,5W 1500Lm 600mA - 595x595mm - INCASSO - RECESSED	25°	corpo BR 8 COLORI		
QDR60I-N1BC/N1BN-XX	SONUS QDR60 1 MODULO LED 17,5W 1500Lm 600mA - 595x595mm - INCASSO - RECESSED	25°	corpo NE 8 COLORI		
QDR60I-B2BC/B2BN-XX	SONUS QDR60 2 MODULI LED 35W 2900Lm 600mA - 595x595mm - INCASSO - RECESSED	25°	corpo BR 8 COLORI		
QDR60I-N2BC/N2BN-XX	SONUS QDR60 2 MODULI LED 35W 2900Lm 600mA - 595x595mm - INCASSO - RECESSED	25°	corpo NE 8 COLORI		
168	ACCESSORI - ACCESSORIES	-	BR		
169	Rosone verticale - Vertical canopy - H. 110 x 42mm	-	NE		
165	Rosone orizzontale - Horizontal canopy - H. 45 x 130mm	-	BR		
166		-	NE		
980119	Kit di fissaggio a parete - Kit for wall installation	-	-		
980124	Kit di fissaggio a sospensione per pannello cieco - kit for suspension for close panel	-	-		
980123	Kit di fissaggio a sospensione per pannello con moduli Led - kit for suspension for panel with modul Led	-	-		
QDR60I-F-XX	SONUS QDR60 Pannello predisposto per lampada ad incasso - Panel predisposed for recessed light fixture PER CONTROSOFFITTO - FOR FALSE CEILING Quantità minima per colore pz 8 - Minimum qty for each finish: 8	-	8 COLORI	 	a richiesta on request RULED T13 (VEDI CAT GENERALE PAG 79 SEE GENERAL CATALOGUE PAGE 79) + SWING 13 (VEDI CAT GENERALE PAG 49 SEE GENERAL CATALOGUE PAGE 49)

SONUSLINE PANNELLI FONOASSORBENTI CON CORPI ILLUMINANTI - ACOUSTIC PANEL WITH LIGHTING FITTINGS INTEGRATED

CODICE CODE	DESCRIZIONE DESCRIPTION	FASCIO BEAM	COLORE FINISH
SQR60S-B1BC/B1BN-XX	SONUS SQUARE 1 MODULO LED 17,5W 1500Lm 600mA - 595x595mm SOSPENSIONE - SUSPENSION - Quantità minima per colore pz 8 - Minimum qty for each finish: 8	25°	corpo BR 8 COLORI
SQR60S-N1BC/N1BN-XX	SONUS SQUARE 1 MODULO LED 17,5W 1500Lm 600mA - 595x595mm SOSPENSIONE - SUSPENSION - Quantità minima per colore pz 8 - Minimum qty for each finish: 8	25°	corpo NE 8 COLORI
SQR60S-B2BC/B2BN-XX	SONUS SQUARE 2 MODULI LED 35W 2900Lm 600mA - 595x595mm SOSPENSIONE - SUSPENSION - Quantità minima per colore pz 8 - Minimum qty for each finish: 8	25°	corpo BR 8 COLORI
SQR60S-N2BC/N2BN-XX	SONUS SQUARE 2 MODULI LED 35W 2900Lm 600mA - 595x595mm SOSPENSIONE - SUSPENSION - Quantità minima per colore pz 8 - Minimum qty for each finish: 8	25°	corpo NE 8 COLORI
SQR12S-B3BC/B3BN-XX	SONUS SQUARE 3 MODULO LED 53W 4400Lm 600mA - 580x1200mm SOSPENSIONE - SUSPENSION - Quantità minima per colore pz 4 - Minimum qty for each finish: 4	25°	corpo BR 8 COLORI
SQR12S-N3BC/N3BN-XX	SONUS SQUARE 3MODULO LED 53W 4400Lm 600mA - 580x1200mm SOSPENSIONE - SUSPENSION - Quantità minima per colore pz 4 - Minimum qty for each finish: 4	25°	corpo NE 8 COLORI
SQR12S-B6BC/B6BN-XX	SONUS SQUARE 6 MODULI LED 106W 8800Lm 600mA - 580x1200mm SOSPENSIONE - SUSPENSION - Quantità minima per colore pz 4 - Minimum qty for each finish: 4	25°	corpo BR 8 COLORI
SQR12S-N6BC/N6BN-XX	SONUS SQUARE 6 MODULI LED 106W 8800Lm 600mA - 580x1200mm SOSPENSIONE - SUSPENSION - Quantità minima per colore pz 4 - Minimum qty for each finish: 4	25°	corpo NE 8 COLORI
SQR16S-B4BC/B4BN-XX	SONUS SQUARE 4 MODULO LED 70W 5900Lm 600mA - 600x1600mm SOSPENSIONE - SUSPENSION - Quantità minima per colore pz 2 - Minimum qty for each finish: 2	25°	corpo BR 8 COLORI
SQR16S-N4BC/N4BN-XX	SONUS SQUARE 4 MODULO LED 70W 5900Lm 600mA - 600x1600mm SOSPENSIONE - SUSPENSION - Quantità minima per colore pz 2 - Minimum qty for each finish: 2	25°	corpo NE 8 COLORI
SQR16S-B8BC/B8BN-XX	SONUS SQUARE 8 MODULI LED 140W 11800Lm 600mA - 600x1600mm SOSPENSIONE - SUSPENSION - Quantità minima per colore pz 2 - Minimum qty for each finish: 2	25°	corpo BR 8 COLORI
SQR16S-N8BC/N8BN-XX	SONUS SQUARE 8 MODULI LED 140W 11800Lm 600mA - 600x1600mm SOSPENSIONE - SUSPENSION - Quantità minima per colore pz 2 - Minimum qty for each finish: 2	25°	corpo NE 8 COLORI
168	Rosone verticale - Vertical canopy - H. 110 x 42mm	-	BR
169			NE
165	Rosone orizzontale - Horizontal canopy - H. 45 x 130mm	-	BR
166			NE

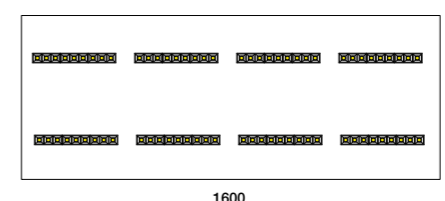
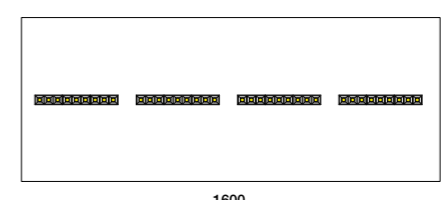
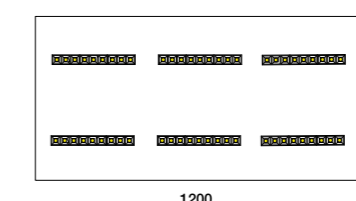
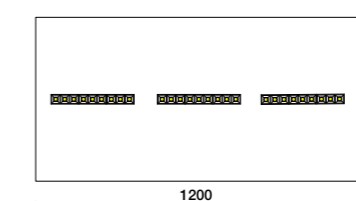
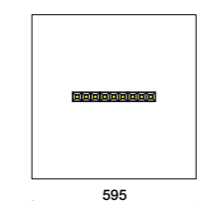
SONUS SQUARE

CODICE CODE	DESCRIZIONE DESCRIPTION	FASCIO BEAM	COLORE FINISH				
RND11S-B1BC/B1BN-XX	SONUS ROUND 31W 3300Lm 500mA - Ø 1200mm Quantità minima per colore pz 2 - Minimum qty for each finish: 2	-	8 COLORI				
168	Rosone verticale - Vertical canopy - H. 110 x 42mm	-	BR				
169			NE				
165	Rosone orizzontale - Horizontal canopy - H. 45 x 130mm	-	BR				
166			NE				
CRC09S-B1BC/B1BN-BG	SONUS CIRCLE Ø 950mm 46W 4000Lm 650mA - LUCE DIRETTA	-	corpo BR pannello BG				
CRC09S-N1BC/N1BN-BG			corpo NE pannello BG				
CRC09S-G1BC/G1BN-BG			corpo GR pannello BG				
CRC09S-B2BC/B2BN-BG	SONUS CIRCLE Ø 950mm 46W 4000Lm 650mA - LUCE DIRETTA+INDIRETTA	-	corpo BR pannello BG				
CRC09S-N2BC/N2BN-BG			corpo NE pannello BG				
CRC09S-G2BC/G2BN-BG			corpo GR pannello BG				
CRC13S-B1BC/B1BN-BG	SONUS CIRCLE Ø 1250mm 58W 4800Lm 500mA - LUCE DIRETTA	-	corpo BR pannello BG				
CRC13S-N1BC/N1BN-BG			corpo NE pannello BG				
CRC13S-G1BC/G1BN-BG			corpo GR pannello BG				
CRC13S-B2BC/B2BN-BG	SONUS CIRCLE Ø 1250mm 58W 4800Lm 500mA - LUCE DIRETTA+INDIRETTA	-	corpo BR pannello BG				
CRC13S-N2BC/N2BN-BG			corpo NE pannello BG				
CRC13S-G2BC/G2BN-BG			corpo GR pannello BG				

IP 20 UGR < 19 a richiesta on request

SONUS CIRCLE

IP 40 a richiesta on request

OUTSIDE  **APPARECCHI DA ESTERNO**
OUTDOOR FIXTURES

EYES

MICRO INCASSI PLAFONE E PARETE - CEILING-WALL MICRO RECESSED SPOT

EYES 20

EYES 20 BASIC

Foro ø 16mm - 1,2W - 90Lm



EYES 20

Foro ø 17mm - 1,2W - 120Lm



EYES 20 HANDRAIL

Foro ø 16mm - 1,2W - 100Lm



EYES 40

EYES 40 BASIC

Foro ø 28,5mm - 4,2W - 500Lm



EYES 40

Foro ø 28mm - 3,5W - 360Lm



EYES 40 ORIENTABILE

Foro ø 34mm - 2W - 150Lm



EYES 80

EYES 80

Foro ø 61mm - 3,5W - 350Lm



EYES 90

EYES 90

Foro ø 73mm - 5,2W - 700Lm



EYES MICRO INCASSI PLAFONE E PARETE - CEILING-WALL MICRO RECESSED SPOT



PLAFONE - PARETE - CEILING/WALL

CORRIMANO - HANDRAIL

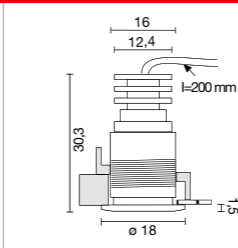
CODICE CODE	DESCRIZIONE DESCRIPTION	FASCIO BEAM	COLORE FINISH
E900-G-LBC/LBN/LBI	EYES 20 BASIC Fix. Ghiera/Locknut - Foro \varnothing 16mm 1,2W 90Lm 350mA IP65	60°	CR
E900-M-LBC/LBN/LBI	EYES 20 BASIC Fix. Molla/Spring - Foro \varnothing 16mm 1,2W 90Lm 350mA IP65	60°	CR
186-5	ACCESSORI - ACCESSORIES Cassaforma per pareti solide - Concrete wall pit	-	-
645732	Driver consigliato - Recommended driver ON-OFF IP20 2,5/42W - 150/1050mA	-	-
E881-G-LBC/LBN-68	EYES 20 TONDO Fix. Ghiera/Locknut - Foro \varnothing 17mm 1,2W 120Lm 350mA IP68	100°	CR
E881-GQ-LBC/LBN68	EYES 20 QUADRO Fix. Ghiera/Locknut - Foro \varnothing 17mm 1,2W 120Lm 350mA IP68	100°	CR
E881-M-LBC/LBN-68	EYES 20 TONDO Fix. Molla/Spring - Foro \varnothing 17mm 1,2W 120Lm 350mA IP68	100°	CR
E881-MQ-LBC/LBN68	EYES A-1 QUADRO Fix. Molla/Spring - Foro \varnothing 17mm 1,2W 120Lm 350mA IP68	100°	CR
186-5	ACCESSORI - ACCESSORIES Cassaforma per pareti solide - Concrete wall pit	-	-
645732	Driver consigliato - Recommended driver ON-OFF IP20 2,5/42W - 150/1050mA	-	-
E901-M-LBC/LBN	EYES 20 HANDRAIL Fix. Molla/Spring - Foro \varnothing 16mm 2W 110Lm 500mA IP65 per CORRIMANO - for HANDRAIL	60°	INOX
645086	Driver consigliato - Recommended driver ON-OFF 20W IP20 500mA	-	-

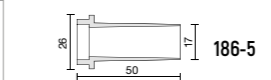
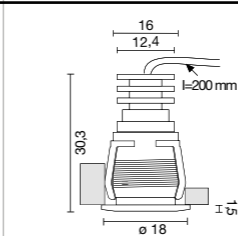

foro 16mm



foro 16mm

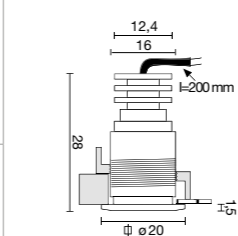

foro 17mm

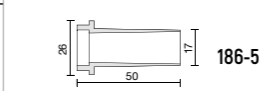
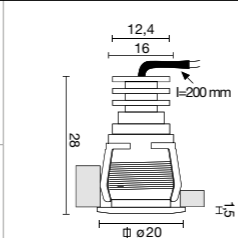

foro 17mm

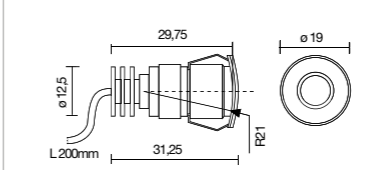

foro 16mm

EYES 20 BASIC

 a richiesta on request
 IP 65 EM

EYES 20

 a richiesta on request
 IP 68 EM

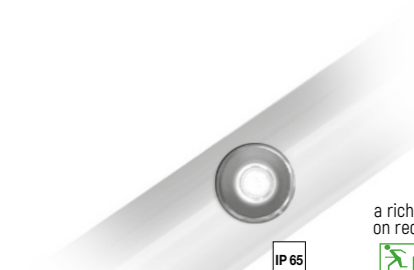
EYES 20 HANDRAIL

 a richiesta on request
 IP 65 EM

EYES MICRO INCASSI PLAFONE E PARETE - CEILING-WALL MICRO RECESSED SPOT

CODICE CODE	DESCRIZIONE DESCRIPTION	FASCIO BEAM	COLORE FINISH		
E894-G-LBC/LBN	EYES 40 BASIC Fix. Ghiera/Locknut - Foro \varnothing 28,5mm 4,2W 550Lm 350mA IP65	10°	CR		
E897-G-LBC/LBN		30°	CR		
E894-M-LBC/LBN	EYES 40 BASIC Fix. Molla/Spring - Foro \varnothing 28,5mm 4,2W 550Lm 350mA IP65	10°	CR		
E897-M-LBC/LBN		30°	CR		
186-3	ACCESSORI - ACCESSORIES Cassaforma per pareti solide - Concrete wall pit	-	-		
645732	Driver consigliato - Recommended driver ON-OFF IP20 2,5/42W - 150/1050mA	-	-		
E886-G-LBC/LBN-C	EYES 40 TONDO/ROUND Fix. Ghiera/Locknut - \varnothing 28mm 3,5W 360Lm 350mA IP65	45°	CR		
E886-GQ-LBC/LBN-C	EYES 40 QUADRO/SQUARE Fix. Ghiera/Locknut - Foro \varnothing 28mm 3,5W 360Lm 350mA IP65	45°	CR		
E886-M-LBC/LBN-C	EYES 40 TONDO/ROUND Fix. Molla/Spring - Foro \varnothing 28mm 3,5W 350Lm 370mA IP66	45°	CR		
E886-MQ-LBC/LBN-C	EYES 40 QUADRO/SQUARE Fix. Molla/Spring - Foro \varnothing 28mm 3,5W 350Lm 370mA IP66	45°	CR		
E871-M-LBC/LBN-C	EYES 40 FLAT TONDO/ROUND Foro \varnothing 28mm 3,5W 300Lm 350mA IP68	45°	INOX		
E871-MQ-LBC/LBN-C	EYES 40 FLAT QUADRO/SQUARE Foro \varnothing 28mm 3,5W 300Lm 350mA IP68	45°	INOX		
186-3	ACCESSORI - ACCESSORIES Cassaforma per pareti solide - Concrete wall pit	-	-		
645732	Driver consigliato - Recommended driver ON-OFF IP20 2,5/42W - 150/1050mA	-	-		
E1219-LBC/LBN	EYES 40 ORIENTABILE Fix. Molla/Spring - Foro \varnothing 34mm 2W 150Lm 500mA IP65	10°	BR		
E1220-LBC/LBN		10°	NE		
E1223-LBC/LBN		10°	ALS		
E1221-LBC/LBN		25°	BR		
E1222-LBC/LBN		25°	NE		
E1224-LBC/LBN		25°	ALS		
644758-5	Driver consigliato - Recommended driver ON OFF 15W IP20 350mA	-	-		

PLAFONE - PARETE - CEILING/WALL

PLAFONE

EYES 40 BASIC

 a richiesta on request
IP 65 EM

EYES 40

 a richiesta on request
IP 68 EM

EYES 40 ORIENTABILE

IP 65

EYES MICRO INCASSI PLAFONE E PARETE - CEILING-WALL MICRO RECESSED SPOT

CODICE CODE	DESCRIZIONE DESCRIPTION	FASCIO BEAM	COLORE FINISH
E8496-LBC/LBN-10-I		10°	INOX
E8496-LBC/LBN-30-I	EYES 80 TONDO/ROUND Foro ø 61mm 1,2W 110Lm 350mA IP67 IK7 NEW	30°	INOX
E8496-LBC/LBN-EL-I		EL 8X35°	INOX
E8394AS-LBC/LBN-I	EYES 80 TONDO/ROUND Foro ø 61mm 1,2W 180Lm 350mA IP67 IK07	ASIM	INOX
E8496-LBC/LBN-10-Q-I		10°	INOX
E8496-LBC/LBN-30-Q-I	EYES 80 QUADRO/SQUARE Foro ø 61mm 1,2W 110Lm 350mA IP67 IK7 NEW	30°	INOX
E8496-LBC/LBN-EL-Q-I		EL 8X35°	INOX
E8394AS-LBC/LBN-Q-I	EYES 80 QUADRO/SQUARE Foro ø 61mm 1,2W 180Lm 350mA IP67 IK07	ASIM	INOX
646308	ACCESSORI - ACCESSORIES Connettore - Connector IP68 ø da 7 a 12mm	-	-
645732	Driver consigliato - Recommended driver ON-OFF IP20 2,5/42W - 150/1050mA	-	-
E8140-MLBC/MLBN-25/40		25 - 40°	BI
E8141-MLBC/MLBN-25/40	EYES 90 Foro ø 73 5,2W 700Lm 150mA IP65	25 - 40°	NE
E8142-MLBC/MLBN-25/40		25 - 40°	GR
148	ACCESSORI - ACCESSORIES Cassaforma per installazioni nel calcestruzzo - Concrete installation box	-	ALL
646209	Driver consigliato - Recommended driver ON OFF 6W IP20 150mA	-	-

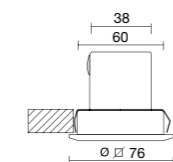

COB

COB ASIM

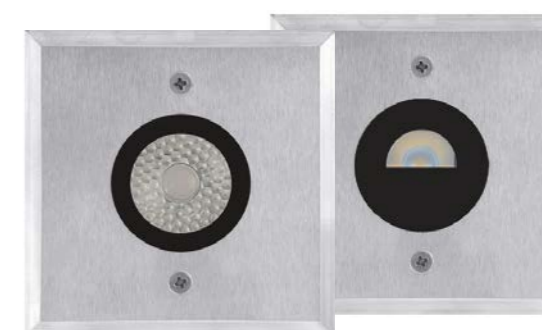

COB

COB ASIM

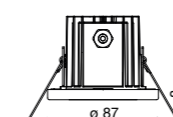
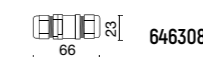

PLAFONE - PARETE - CEILING/WALL

I CARATTERI ROSSI DEL CODICE INDICANO UNA VARIANTE - THE RED CHARACTERS IN A CODE INDICATE AN ALTERNATIVE

EYES GROUND

MICRO INCASSI CALPESTABILI - WALKOVER MICRO RECESSED SPOT

MICRO INCASSI LUCE CAMMINAMENTI E PARETE - PATHWAY RECESSED SPOT INGROUND/CEILING **OUTSIDE**

EYES 40 GROUND

3,5W - 370Lm



EYES 40 COVER

1,5W - 150Lm



EYES 40 RING

1,5W - 150Lm

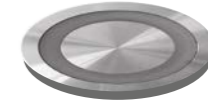

EYES 40

EYES 80 GROUND

3,5/4,2W - 350/600Lm

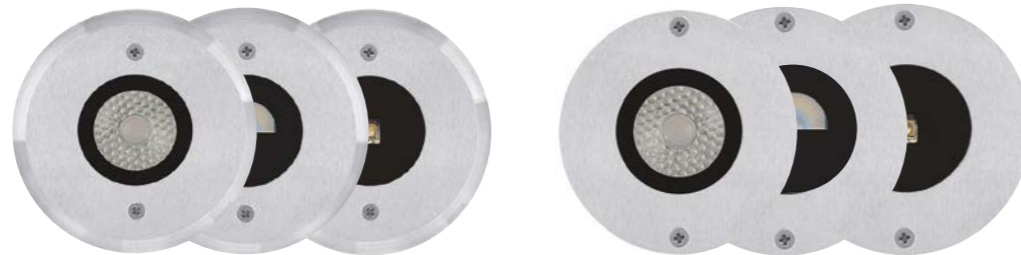

LED COB

LED COB ASIM

RGB

LED COB

LED COB ASIM

RGB

EYES 80 COVER

1,5W



EYES 80 PASS

1,2/3,5W



RGB



EYES 80

STANDARD
Telaio in battuta
Smooth edge trim

FLAT
Telaio a filo
Flush trim



LED COB

LED COB ASIM

RGB



EYES 90 GROUND

4,2/5,2W - 540/760Lm



LED COB SIM

LED COB ASIM

RGB

NEW EYES 90 GROUND GU10

senza lampada - without lamp



GU10

EYES 90

EYES MICRO INCASSI CALPESTABILI - WALKOVER MICRO RECESSED SPOT



CODICE CODE	DESCRIZIONE DESCRIPTION	FASCIO BEAM	COLORE FINISH		
E883-N-LBC/LBN-C	EYES 40 GROUND TONDO 3,5W 370Lm 350mA IP68	45°	INOX		<p>EYES 40 GROUND</p> <p>GLARE CONTROL - ASIM</p>
E891-N-LBC/LBN	EYES 40 GROUND TONDO GLARE CONTROL - 1,2W 110Lm 150mA IP68	ASIM 50°	INOX		
KTE891-N-LBC/LBN	EYES 40 GROUND TONDO GLARE CONTROL KIT - 1,2W 110Lm 150mA IP68 + DRIVER	ASIM 50°	INOX		
186-6	ACCESSORI - ACCESSORIES Cassaforma Foro ø 34mm per driver 646760 (a richiesta) IP rated housing, hole ø 34mm for spot and driver 646760 (not included)	-	-		
186-7	Cassaforma Foro ø 34mm (driver remoto a richiesta) Housing, hole ø 34mm for spot and remote driver (not included)	-	-		
E8496-LBC/LBN-10-SM	EYES 80 GROUND TONDO/ROUND 1,2W 110Lm 350mA IP67 IK7 NEW	10°	INOX		<p>EYES 80 GROUND</p> <p>LED COB LED COB ASIM RGB</p>
E8496-LBC/LBN-30-SM		30°	INOX		
E8496-LBC/LBN-EL-SM		EL 8X35°	INOX		
E8394AS-LBC/LBN-SM	EYES 80 GROUND TONDO 1,2W 130Lm 350mA IP67 IK07	ASIM	INOX		<p>EYES 80 GROUND QUADRO/SQUARE 1,2W 110Lm 350mA IP67 IK7 NEW</p> <p>LED COB LED COB ASIM RGB</p>
E8394-RGB-SM	EYES 80 GROUND TONDO/ROUND RGB - 3,5W 350mA IP67 IK07	100°	INOX		
E8496-LBC/LBN-10-SMQ	10°	INOX			
E8496-LBC/LBN-30-SMQ	30°	INOX		<p>EYES 80 GROUND QUADRO 1,2W 130Lm 350mA IP67 IK07</p> <p>LED COB LED COB ASIM RGB</p>	
E8496-LBC/LBN-EL-SMQ	EL 8X35°	INOX			
E8394AS-LBC/LBN-SMQ	ASIM	INOX			
E8394-RGB-SMQ	EYES 80 GROUND QUADRO RGB - 3,5W 350mA IP67 IK07	100°	INOX		<p>EYES 80 GROUND FLAT TONDO/ROUND 1,2W 110Lm 350mA IP67 IK7 NEW</p> <p>LED COB FLAT LED COB ASIM FLAT RGB FLAT</p>
E8496-LBC/LBN-10	10°	INOX			
E8496-LBC/LBN-30	30°	INOX			
E8496-LBC/LBN-EL	EL 8X35°	INOX		<p>EYES 80 GROUND TONDO FLAT 1,2W 130Lm 350mA IP67 IK07</p> <p>LED COB FLAT LED COB ASIM FLAT RGB FLAT</p>	
E8394AS-LBC/LBN	ASIM	INOX			
E8394-RGB	100°	INOX			
185	ACCESSORI - ACCESSORIES Cassaforma per incasso - Recessed box	-	-		<p>185</p> <p>646308</p>
646308	Connettore - Connector IP68 ø da 7 a 12mm	-	-		
645732	Driver consigliato - Recommended driver ON-OFF IP20 2,5/42W - 150/1050mA	-	-		

I CARATTERI ROSSI DEL CODICE INDICANO UNA VARIANTE - THE RED CHARACTERS IN A CODE INDICATE AN ALTERNATIVE

EYES MICRO INCASSI CALPESTABILI - WALKOVER MICRO RECESSED SPOT



CODICE CODE	DESCRIZIONE DESCRIPTION	FASCIO BEAM	COLORE FINISH	
E8140F-MLBC/MLBN25/40	EYES 90 GROUND 5,2W 730Lm 150/350mA IP65 IK07	25 - 40°	INOX	<p>EYES 90 GROUND</p> <p>LED COB SIM LED COB ASIM RGB</p>
E8140F-MLBC/MLBN-AS	EYES 90 GROUND 4,2W 570Lm 350mA IP65 IK07	ASIM 10°	INOX	
E8140F-RGB-10/30/45	EYES 90 GROUND RGB 3x1,2W 350mA IP65 IK07	10 - 25 - 40°	INOX	
185-C	ACCESSORI - ACCESSORIES Cassaforma per incasso in materiale plastico - Recessed box for plastic materials	-	-	<p>185-C IP 65 IK 07</p>
646209	Driver consigliato - Recommended driver ON OFF 6W IP20 150mA	-	-	
E8140F-GUT	EYES 90 TONDO GROUND GU10 IP65	-	INOX	<p>NEW EYES 90 GROUND GU10</p>
E8140F-GUQ	EYES 90 QUADRO GROUND GU10 IP65	-	INOX	<p>Gli apparecchi non sono muniti di lampada Fittings are not equipped with bulb</p> <p style="text-align: right;">IP 65</p>

EYES MICRO INCASSI CALPESTABILI - WALKOVER MICRO RECESSED SPOT



CODICE CODE	DESCRIZIONE DESCRIPTION	FASCIO BEAM	COLORE FINISH				
TERRA - INGROUND	E880-LBC/LBN/LBL					EYES 40 RING 	
	186-3	ACCESSORI - ACCESSORIES Cassaforma Foro ø 32mm - Recessed box hole 32mm	-	-			186-3
	644758-5	Driver consigliato - Recommended driver ON OFF 6W IP20 500mA	-	-			
PARETE - WALL	E875-LBC/LBN/LBI			45°	INOX		EYES 40 COVER
	E877-LBC/LBN/LBI	EYES 40 COVER 1,5W 150Lm 500mA IP68 IK09 - MONO EMISSIONE - SINGLE SIDE EMISSION	125°	INOX			
	E876-LBC/LBN/LBI			45°	INOX		
	E878-LBC/LBN/LBI	EYES 40 COVER 1,5W 150Lm 500mA IP68 IK09 - BIEMISSIONE - DOUBLE SIDE EMISSION	125°	INOX			
	186-3	ACCESSORI - ACCESSORIES Cassaforma Foro ø 32mm - Recessed pit, hole cutout ø32mm	-	-			186-3
	644758-5	Driver consigliato - Recommended driver ON OFF 6W IP20 500mA	-	-			
TERRA	E8392-LBI/LBC	EYES 80 COVER 8 LED 1,5W 220-240V IK10 IP67	-		cupola ALL corpo INOX		EYES 80 COVER
	E8394-VD-LBC/LBN	EYES 80 PASS 1,2W 350mA IK10 IP67	-		INOX		EYES 80 PASS
	E8394-VD-RGB	EYES 80 PASS RGB - 1,2/3,5W 350mA IK10 IP67	-		INOX		
	185	ACCESSORI - ACCESSORIES Cassaforma per incasso - Recessed box	-	-			185
	645732	Driver consigliato - Recommended driver ON-OFF IP20 2,5/42W - 150/1050mA	-	-			

I CARATTERI ROSSI DEL CODICE INDICANO UNA VARIANTE - THE RED CHARACTERS IN A CODE INDICATE AN ALTERNATIVE

OLODUM 130

OLODUM 130 C
15W - 1000Lm



OLODUM 180

OLODUM 180 C
9,5W - 800Lm











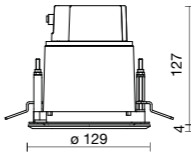

OLODUM 220

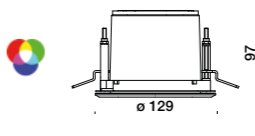
OLODUM 220 C
20W - 1900/2300Lm

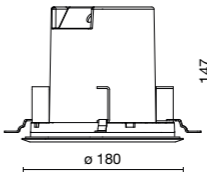

OLODUM CEILING INCASSI PLAFONE - CEILING RECESSED SPOT



CODICE CODE	DESCRIZIONE DESCRIPTION	FASCIO BEAM	COLORE FINISH		
E8185CI-LBC/LBN15/24/40	OLODUM 130 C Foro ø 120mm 15W 900/2200Lm 350mA IP67 IK10 + DRIVER IP67	15 - 24 - 40°	INOX		<p>OLODUM 130 C</p>  <p>RGB</p>
E8185-I-RGB10/30/45	OLODUM 130 C RGB - Foro ø 120mm 3x1,2W 350mA IP67 IK07	10 - 30 - 40°	INOX		
646308	ACCESSORI - ACCESSORIES Connettore - Connector IP68 ø da 7 a 12mm	-	-	 foro 120mm 646308	
E827II-LBC/LBN-S/FL/WF	OLODUM 180 C MDF Foro ø 162mm 8W 660Lm 200mA IP67	15 - 30 - 40°	INOX		<p>OLODUM 180 C MDF</p>   <p>MATERIALE TERMOPLASTICO SUPER RESISTENTE THERMOPLASTIC MATERIAL SUPER RESISTENT</p> <p>ANELLO IN ACCIAIO INOX (AISI 316L) STAINLESS STEEL FRAME (AISI 316L)</p>
646308	ACCESSORI - ACCESSORIES Connettore - Connector IP68 ø da 7 a 12mm	-	-	 foro 162mm 646308	<p>a richiesta on request</p>  
INV 1052	Kit emergenza - Emergency kit - 1H	-	-		
INV 1052-3	Kit emergenza - Emergency kit - 3H	-	-		

OLODUM CEILING INCASSI PLAFONE - CEILING RECESSED SPOT



CODICE CODE	DESCRIZIONE DESCRIPTION	FASCIO BEAM	COLORE FINISH
E81281-LBC/LBN-S/FL/WF	OLODUM 220 C Foro ø 201mm 20W 1210Lm 500mA IP67 IK10	18 - 40 - 60°	INOX
E81281-LBC/LBN-AS	OLODUM 220 C Foro ø 201mm 20W 1900Lm 500mA IP67 IK10 - ASIMMETRICO - ASYMMETRIC	ASIM	INOX
646308	ACCESSORI - ACCESSORIES Connettore - Connector IP68 ø da 7 a 12mm	-	-
INV 1052	Kit emergenza - Emergency kit - 1H	-	-
INV 1052-3	Kit emergenza - Emergency kit - 3H	-	-
E81291-LBC/LBN-S/FL/WF	OLODUM 220 C MCL Foro ø 201mm 20W 2100Lm 500mA IP67 IK10	18 - 40 - 60°	INOX
E81291-LBC/LBN-AS	OLODUM 220 C MCL Foro ø 201mm 20W 1900Lm 500mA IP67 IK10 - ASIMMETRICO- ASYMMETRIC	ASIM	INOX
646308	ACCESSORI - ACCESSORIES Connettore - Connector IP68 ø da 7 a 12mm	-	-
INV 1052	Kit emergenza - Emergency kit - 1H	-	-
INV 1052-3	Kit emergenza - Emergency kit - 3H	-	-

OLODUM 220 C

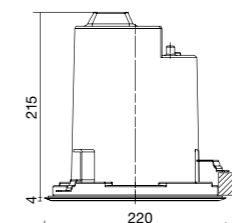

foro 201mm 66 **646308**

a richiesta on request

OLODUM 220 C MDF

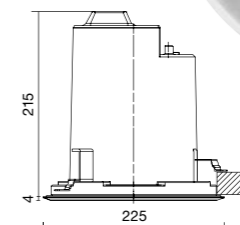

foro 201mm 66 **646308**

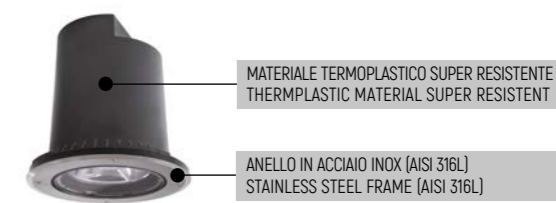













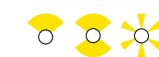

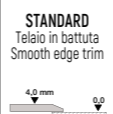

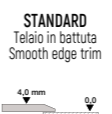
MATERIALE TERMOPLASTICO SUPER RESISTENTE
THERMPLASTIC MATERIAL SUPER RESISTENT

ANELLO IN ACCIAIO INOX (AISI 316L)
STAINLESS STEEL FRAME (AISI 316L)

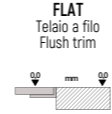
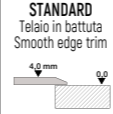
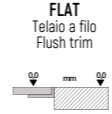
a richiesta on request

OLODUM
INCASSI CALPESTABILI E CARRABILI - WALK- AND DRIVEOVER RECESSED SPOT

				MDF	RULED	LOCKsystem	FULL GLASS	SEGNALAZIONE		
				FLAT Telaio a filo Flush trim	STANDARD Telaio in battuta Smooth edge trim	FLAT Telaio a filo Flush trim	STANDARD Telaio in battuta Smooth edge trim	FLAT Telaio a filo Flush trim		
OLODUM 130	<p>OLODUM 130 14,9W - 930Lm</p> 			 					<p>130 FULL GLASS 14,9W - 1000Lm</p> 	<p>130 COVER 2W - 130Lm</p>  
OLODUM 180	<p>OLODUM 180 9,5W - 1200Lm</p> 			 	 				<p>220 COVER 14/28W - 280/560Lm</p>  	
OLODUM 220	<p>OLODUM 220 20W - 1600/3100Lm</p> 				 				<p>220 COVER 14/28W - 280/560Lm</p>  	
OLODUM 300	<p>OLODUM 300 35W - 4300Lm</p> 									



OLODUM INCASSI CALPESTABILI E CARRABILI - WALK- AND DRIVEOVER RECESSED SPOT

CODICE CODE	DESCRIZIONE DESCRIPTION	FASCIO BEAM	COLORE FINISH	
E8184C-LBC/LBN-15/24/40	OLODUM 130 TONDO/ROUND 14,9W 930Lm 350mA IP67 IK07	15 - 24 - 40°	INOX	<p>130-T 130-Q 130 FLAT-T</p> <p>STANDARD Telaio in battuta Smooth edge trim</p> <p>FLAT Telaio a filo Flush trim</p>
E7120C-LBC/LBN-15/24/40	OLODUM 130 QUADRO/SQUARE 14,9W 930Lm 350mA IP67 IK07	15 - 24 - 40°	INOX	
E8384CT-LBC/LBN15/24/40	OLODUM 130 FLAT TONDO/ROUND 14,9W 930Lm 350mA IP67 IK07	15 - 24 - 40°	INOX	
E8186-R	OLODUM 130 GU10 Foro ø 120mm IP67 - GU10	-	INOX	<p>GU10</p> <p>130 GU10</p> <p>Gli apparecchi non sono muniti di lampada Fittings are not equipped with bulb</p>
E8384CTV-BC/BN15/24/40	OLODUM 130 FULL GLASS 14,9W 1000Lm 350mA IP67 IK07	15 - 24 - 40°	INOX	<p>130 FULL GLASS</p>
645732	Driver consigliato - Recommended driver ON-OFF IP20 2,5/42W - 150/1050mA	-	-	
E8396-LBC/LBN/LBI/LBL	OLODUM 130 COVER 2W 130Lm 500mA IP67 IK10 - MONO EMISSIONE - SINGLE SIDE EMISSION	MONO	GR	<p>130 COVER</p>
E8397-LBC/LBN/LBI/LBL	OLODUM 130 COVER 2W 130Lm 500mA IP67 IK10 - BIEMISSIONE - DOUBLE SIDE EMISSION	BI	GR	
E8398-LBC/LBN/LBI/LBL	OLODUM 130 COVER 2W 130Lm 500mA IP67 IK10 - RADIALE - RADIAL	RADIALE	GR	
E8272-LBC/LBN-S/FL/WF/AS	OLODUM 180 MDF SHORT TONDO/ROUND 9,5W 1200Lm 250mA IP67 IK10 MATERIALE PLASTICO - THERMOPLASTIC MATERIAL	S - FL - WF - AS	INOX	<p>180 MDF SHORT 180 FLAT-T MDF SHORT 180 FLAT-Q MDF SHORT</p> <p>MDF MATERIALE PLASTICO - THERMOPLASTIC MATERIAL</p>
E8277T-LBC/LBN-S/FL/WF/AS	OLODUM 180 FLAT MDF SHORT TONDO/ROUND 9,5W 1200Lm 250mA IP67 IK10 MATERIALE PLASTICO - THERMOPLASTIC MATERIAL	S - FL - WF - AS	INOX	
E8277-LBC/LBN-S/FL/WF/AS	OLODUM 180 FLAT MDF SHORT QUADRO/SQUARE 9,5W 1200Lm 250mA IP67 IK10 MATERIALE PLASTICO - THERMOPLASTIC MATERIAL	S - FL - WF - AS	INOX	
E8272-LBC/LBN-12/55/75/ASI/AE	OLODUM-RULED 180 MDF TONDO/ROUND 9,5W 1050Lm 350mA IP67 IK10 MATERIALE PLASTICO - THERMOPLASTIC MATERIAL	12 - 45 - 60 AS - AE	INOX	<p>RULED 180 MDF RULED 180 FLAT MDF-T RULED 180 FLAT MDF-Q</p> <p>MDF MATERIALE PLASTICO - THERMOPLASTIC MATERIAL</p>
E8272F-LBC/LBN-12/55/75/ASI/AE	OLODUM-RULED 180 FLAT MDF TONDO/ROUND 9,5W 1050Lm 350mA IP67 IK10 MATERIALE PLASTICO - THERMOPLASTIC MATERIAL	12 - 45 - 60 AS - AE	INOX	
E8277F-LBC/LBN-12/55/75/ASI/AE	OLODUM-RULED 180 FLAT MDF QUADRO/SQUARE 9,5W 1050Lm 350mA IP67 IK10 MATERIALE PLASTICO - THERMOPLASTIC MATERIAL	12 - 45 - 60 AS - AE	INOX	
E8272-LBC/LBN-12/55/75/ASI/AE-ST	OLODUM-RULED 180 TONDO/ROUND - LOCKsystem 9,5W 1050Lm 350mA IP68 IK10 MATERIALE PLASTICO - THERMOPLASTIC MATERIAL	12 - 45 - 60 AS - AE	INOX	<p>RULED 180 MDF LOCKsystem</p> <p>MDF MATERIALE PLASTICO - THERMOPLASTIC MATERIAL</p>

I CARATTERI ROSSI DEL CODICE INDICANO UNA VARIANTE - THE RED CHARACTERS IN A CODE INDICATE AN ALTERNATIVE

OLODUM INCASSI CALPESTABILI E CARRABILI - WALK- AND DRIVEOVER RECESSED SPOT



CODICE CODE	DESCRIZIONE DESCRIPTION	FASCIO BEAM	COLORE FINISH	
E8128-LBC/LBN-S/FL/WF/AS	OLODUM 220 TONDO 20W 1217Lm 500mA IP67 IK10	S - FL - WF - AS	INOX	<p>OLODUM 220</p> <p>STANDARD Telaio in battuta Smooth edge trim</p> <p>FLAT Telaio a filo Flush trim</p>
E7070-LBC/LBN	OLODUM 220 QUADRO 27,5W 3100Lm 750mA IP67 IK10	25°	INOX	
E8131T-LBC/LBN-S/FL/WF/AS	OLODUM 220 FLAT TONDO 20W 1217Lm 500mA IP67 IK10	S - FL - WF - AS	INOX	
E8129-LBC/LBN-S/FL/WF/AS	OLODUM 220 MDF TONDO 20W 1217Lm 500mA IP67 IK10 MATERIALE PLASTICO - THERMOPLASTIC MATERIAL	S - FL - WF - AS	INOX	<p>220 MDF 220 FLAT-T MDF 220 FLAT-Q MDF SHORT</p>
E8132T-LBC/LBN-S/FL/WF/AS	OLODUM 220 FLAT MDF TONDO 20W 1217Lm 500mA IP67 IK10 MATERIALE PLASTICO - THERMOPLASTIC MATERIAL	S - FL - WF - AS	INOX	
E8132-LBC/LBN-S/FL/WF/AS	OLODUM 220 FLAT MDF QUADRO 20W 1217Lm 500mA IP67 IK10 MATERIALE PLASTICO - THERMOPLASTIC MATERIAL	S - FL - WF - AS	INOX	
E8129-LBC/LBN-12/55/75/ASI/AE	OLODUM-RULED 220 MDF TONDO 20W 2000Lm 700mA IP67 IK10 MATERIALE PLASTICO - THERMOPLASTIC MATERIAL	12 - 45 - 60 AS - AE	INOX	<p>RULED 220 MDF RULED 220 FLAT MDF-T RULED 220 FLAT MDF-Q</p> <p>MDF MATERIALE PLASTICO - THERMOPLASTIC MATERIAL</p> <p>a richiesta on request</p> <p>IK10 IP67 DALI</p>
E8129F-LBC/LBN-12/55/75/ASI/AE	OLODUM-RULED 220 FLAT MDF TONDO 20W 2000Lm 700mA IP67 IK10 MATERIALE PLASTICO - THERMOPLASTIC MATERIAL	12 - 45 - 60 AS - AE	INOX	
E8132F-LBC/LBN-12/55/75/ASI/AE	OLODUM-RULED 220 FLAT MDF QUADRO 20W 2000Lm 700mA IP67 IK10 MATERIALE PLASTICO - THERMOPLASTIC MATERIAL	12 - 45 - 60 AS - AE	INOX	
E8129-LBC/LBN-12/55/75/ASI/AE-ST	OLODUM-RULED 220 MDF TONDO - LOCKsystem 20W 1600Lm 700mA IP68 IK10 MATERIALE PLASTICO - THERMOPLASTIC MATERIAL	12 - 45 - 60 AS - AE	INOX	<p>RULED 220 MDF LOCKsystem 220 MDF LOCKsystem</p> <p>MDF MATERIALE PLASTICO - THERMOPLASTIC MATERIAL</p> <p>a richiesta on request</p> <p>IK10 IP68 DALI</p>
E8129-LBC/LBN-S/FL/WF-ST	OLODUM 220 MDF TONDO - LOCKsystem 20W 2100Lm 500mA IP68 IK10 MATERIALE PLASTICO - THERMOPLASTIC MATERIAL	S - FL - WF	INOX	
E8202-LBC/LBN	OLODUM 220 COVER 14W 280Lm 700mA IP67 IK10 - MONO EMISSIONE - SINGLE SIDE EMISSION	MONO	NE	<p>220 COVER</p> <p>a richiesta on request</p> <p>IK10 IP67 DALI</p>
E8203-LBC/LBN	OLODUM 220 COVER 28W 560Lm 700mA IP67 IK10 - BIEMISSIONE - DOUBLE SIDE EMISSION	BI	NE	
E8340-LBC/LBN-S/FL/WF	OLODUM 300 TONDO 35W 4300Lm 900mA IP67 IK10	S - FL - WF - AS	INOX	<p>300 300 FLAT-T 120 FLAT-Q</p> <p>a richiesta - on request</p> <p>DIM 1+10V DALI IK10 IP67</p>
E8346-LBC/LBN-S/FL/WF	OLODUM 300 FLAT TONDO 35W 4300Lm 900mA IP67 IK10	S - FL - WF - AS	INOX	
E8345-LBC/LBN-S/FL/WF	OLODUM 300 FLAT QUADRO 35W 4300Lm 900mA IP67 IK10	S - FL - WF - AS	INOX	
E8340-LBC/LBN-12/55/75/ASI/AE	OLODUM-RULED 300 MDF TONDO 34W 3400Lm 1200mA IP67 IK10 MATERIALE PLASTICO - THERMOPLASTIC MATERIAL	12 - 45 - 60 AS - AE	INOX	<p>RULED 300 MDF RULED 300 FLAT-T MDF RULED 300 FLAT-Q MDF</p> <p>MDF MATERIALE PLASTICO - THERMOPLASTIC MATERIAL</p> <p>a richiesta on request</p> <p>IK10 IP67 DALI</p>
E8340F-LBC/LBN-12/55/75/ASI/AE	OLODUM-RULED 300 FLAT MDF TONDO 35W 3400Lm 1200mA IP67 IK10 MATERIALE PLASTICO - THERMOPLASTIC MATERIAL	12 - 45 - 60 AS - AE	INOX	
E8345F-LBC/LBN-12/55/75/ASI/AE	OLODUM-RULED 300 FLAT MDF QUADRO 35W 3400Lm 1200mA IP67 IK10 MATERIALE PLASTICO - THERMOPLASTIC MATERIAL	12 - 45 - 60 AS - AE	INOX	

LONGLIGHT GROUND

INCASSI LINEARI DA ESTERNO - LINEAR INGROUND RECESSED LIGHTS



LONGLIGHT GROUND MINI

da 220Lm a 2100Lm - Fascio/Beam 20°



LONGLIGHT GROUND MINI

IK 07
IP 67 Carico statico/Static load 500 kg

LUNGHEZZE/ LENGTH	VETRO/GLASS	RGB
128 mm	VT Vetro trasparente/Transparent glass	
390 mm	VS Vetro sabbato/Frosted glass VT Vetro trasparente/Transparent glass	RGB a richiesta on request
690 mm	VS Vetro sabbato/Frosted glass VT Vetro trasparente/Transparent glass	RGB a richiesta on request

LONGLIGHT GROUND

da 450Lm a 3100Lm - Fascio/Beam 10°

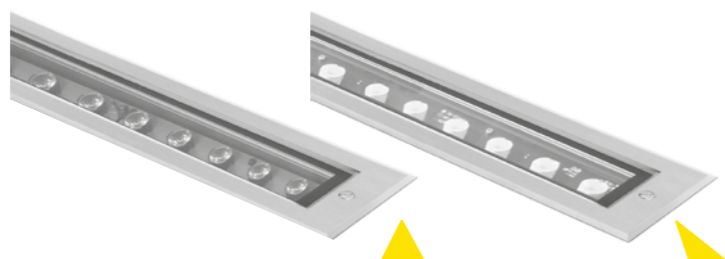

LUNGHEZZE/ LENGTH	VETRO/GLASS	RGB	DALI
375 mm	VT Vetro trasparente/Transparent glass		a richiesta on request DALI
935 mm			
1236 mm			
1536 mm			
1536 mm		RGB a richiesta on request	

LONGLIGHT GROUND POWER

da 900Lm a 4500Lm - Fascio/Beam 10°



LONGLIGHT GROUND

Carico statico/Static load 500 kg

STANDARD
Telaio in battuta
Smooth edge trim

FLAT
Telaio a filo
Flush trim

IK 09
IP 67

LUNGHEZZE/ LENGTH	VETRO/GLASS	DALI
375 mm	VT Vetro trasparente/Transparent glass	a richiesta on request DALI
935 mm		
1236 mm		
1536 mm		

LONGLIGHT GROUND PASS

da 90Lm a 250Lm



LUNGHEZZE/ LENGTH	VETRO/GLASS
375 mm	VS Vetro sabbato/Frosted glass
935 mm	

LONGLIGHT INCASSI LINEARI DA ESTERNO - LINEAR INGROUND RECESSED LIGHTS



CODICE CODE	DESCRIZIONE DESCRIPTION	FASCIO BEAM	COLORE FINISH		
E9054-LBC/LBN	LONGLIGHT GROUND MINI L.128mm - 4,5W 220Lm 350mA IP67 IK07 - VT	20°	INOX		LONGLIGHT GROUND MINI
E9050-LBC/LBN	LONGLIGHT GROUND MINI L.390mm - 8W 350Lm 350mA IP67 IK07 - VT	20°	INOX		
E9052-LBC/LBN	LONGLIGHT GROUND MINI L.390mm - 13,2W 1000Lm 24Vdc IP67 IK07 - VT	20°	INOX		
E9060-LBC/LBN	LONGLIGHT GROUND MINI L.690mm - 16W 700Lm 350mA IP67 IK07 - VT	20°	INOX		
E9062-LBC/LBN	LONGLIGHT GROUND MINI L.690mm - 25,4W 2100Lm 24Vdc IP67 IK07 - VT	20°	INOX		VT Vetro trasparente/Transparent glass a richiesta on request
E8941-LBC/LBN6	LONGLIGHT GROUND L.375mm - 8W 450Lm 350mA IP67 IK09 - VT	10°	INOX	CON TELAIO DI FINITURA IN BATTUTA WITH SMOOTH FINISHING FRAME	LONGLIGHT GROUND
E8951-LBC/LBN-18	LONGLIGHT GROUND L.935mm - 24W 1400Lm 350mA IP67 IK09 - VT	10°	INOX		SIMMETRICO SYMMETRIC
E8957-LBC/LBN-24	LONGLIGHT GROUND L.1236mm - 32W 1800Lm 350mA IP67 IK09 - VT	10°	INOX		
E8958-LBC/LBN-30	LONGLIGHT GROUND L.1536mm - 39W 2200Lm 350mA IP67 IK09 - VT	10°	INOX		
E8946-LBC/LBN-6	LONGLIGHT GROUND FLAT L.380mm - 8W 450Lm 350mA IP67 IK09 - VT - FLAT	10°	INOX	CON TELAIO DI FINITURA A FILO WITH FLUSH FINISHING FRAME	
E8956-LBC/LBN-18	LONGLIGHT GROUND FLAT L.940mm - 24W 1400Lm 350mA IP67 IK09 - VT - FLAT	10°	INOX		
E8942-LBC/LBN-24	LONGLIGHT GROUND FLAT L.1240mm - 32W 1800Lm 350mA IP67 IK09 - VT - FLAT	10°	INOX		
E8943-LBC/LBN-30	LONGLIGHT GROUND FLAT L.1540mm - 39W 2200Lm 350mA IP67 IK09 - VT - FLAT	10°	INOX		
E8941AS-LBC/LBN	LONGLIGHT GROUND L.375mm - 8,5W 590Lm 24V/230V IP67 IK09 - VT ASIMMETRICO - ASYMMETRIC	ASIM	INOX	CON TELAIO DI FINITURA IN BATTUTA WITH SMOOTH FINISHING FRAME	
E8951AS-LBC/LBN	LONGLIGHT GROUND L.935mm - 29,5W 1760Lm 24V/230V IP67 IK09 - VT ASIMMETRICO - ASYMMETRIC	ASIM	INOX		ASIMMETRICO ASYMMETRIC
E8957AS-LBC/LBN	LONGLIGHT GROUND L.1236mm - 38,5W 2690Lm 24V/230V IP67 IK09 - VT ASIMMETRICO - ASYMMETRIC	ASIM	INOX		
E8958AS-LBC/LBN	LONGLIGHT GROUND L.1536mm - 47,5W 3390Lm 24V/230VP67 IK09 - VT ASIMMETRICO - ASYMMETRIC	ASIM	INOX		
E8946AS-LBC/LBN	LONGLIGHT GROUND FLAT L.375mm - 8,5W 590Lm 24V/230V IP67 IK09 - VT ASIMMETRICO - ASYMMETRIC	ASIM	INOX	CON TELAIO DI FINITURA A FILO WITH FLUSH FINISHING FRAME	
E8956AS-LBC/LBN	LONGLIGHT GROUND FLAT L.935mm - 29,5W 1760Lm 24V/230V IP67 IK09 - VT ASIMMETRICO - ASYMMETRIC	ASIM	INOX		
E8942AS-LBC/LBN	LONGLIGHT GROUND FLAT L.1236mm - 38,5W 2690Lm 24V/230V IP67 IK09 - VT ASIMMETRICO - ASYMMETRIC	ASIM	INOX		
E8943AS-LBC/LBN	LONGLIGHT GROUND FLAT L.1536mm - 47,5W 3390Lm 24V/230VP67 IK09 - VT ASIMMETRICO - ASYMMETRIC	ASIM	INOX	VT Vetro trasparente/Transparent glass	a richiesta - on request

LONGLIGHT INCASSI LINEARI DA ESTERNO - LINEAR INGROUND RECESSED LIGHTS



CODICE CODE	DESCRIZIONE DESCRIPTION	FASCIO BEAM	COLORE FINISH		
E8941-LBC/LBN	LONGLIGHT GROUND POWER L.375mm - 16W 900Lm 24Vcd IP67 IK09 - VT	10°	INOX	<p>CON TELAIO DI FINITURA IN BATTUTA WITH SMOOTH FINISHING FRAME</p>	<p>LONGLIGHT GROUND POWER</p>
E8951-LBC/LBN	LONGLIGHT GROUND POWER L.935mm - 46W 2400Lm 24Vcd IP67 IK09 - VT	10°	INOX		
E8957-LBC/LBN	LONGLIGHT GROUND POWER L.1236mm - 50W 3600Lm 24Vcd IP67 IK09 - VT	10°	INOX		
E8958-LBC/LBN	LONGLIGHT GROUND POWER L.1536mm - 74W 4500Lm 24Vcd IP67 IK09 - VT	10°	INOX		
E8946-LBC/LBN	LONGLIGHT GROUND POWER FLAT L.375mm - 16W 900Lm 24Vcd IP67 IK09 - VT - FLAT	10°	INOX	<p>CON TELAIO DI FINITURA A FILO WITH FLUSH FINISHING FRAME</p>	<p>LONGLIGHT GROUND PASS</p>
E8956-LBC/LBN	LONGLIGHT GROUND POWER FLAT L.935mm - 46W 2400Lm 24Vcd IP67 IK09 - VT - FLAT	10°	INOX		
E8942-LBC/LBN	LONGLIGHT GROUND POWER FLAT L.1236mm - 50W 3600Lm 24Vcd IP67 IK09 - VT - FLAT	10°	INOX		
E8943-LBC/LBN	LONGLIGHT GROUND POWER FLAT L.1536mm - 74W 4500Lm 24Vcd IP67 IK09 - VT - FLAT	10°	INOX		
E8910-LBC/LBN	LONGLIGHT GROUND PASS L.375mm - 4W 90Lm 12Vdc IP67 IK09 - VS	-	INOX	<p>CON TELAIO DI FINITURA IN BATTUTA WITH SMOOTH FINISHING FRAME</p>	<p>LONGLIGHT GROUND PASS</p>
E8930-LBC/LBN	LONGLIGHT GROUND PASS L.935mm - 9W 250Lm 12Vdc IP67 IK09 - VS	-	INOX		
E8915-LBC/LBN	LONGLIGHT GROUND PASS FLAT L.375mm - 4W 90Lm 12Vdc IP67 IK09 - VS - FLAT	-	INOX	<p>CON TELAIO DI FINITURA A FILO WITH FLUSH FINISHING FRAME</p>	<p>LONGLIGHT GROUND PASS</p>
E8935-LBC/LBN	LONGLIGHT GROUND PASS FLAT .935mm - 9W 250Lm 12Vdc IP67 IK09 - VS - FLAT	-	INOX		

VT Vetro trasparente/Transparent glass a richiesta on request

VS Vetro sabbato/Frosted glass

SURFACE LINEARI

LINEARI DA TERRA E PARETE DA ESTERNO - WALL/SURFACE OUTDOOR LINEAR LIGHTS



LONGHLIGHT MINI



LUNGHEZZE/LENGTH	VETRO/GLASS	RGB
118 mm	VT Vetro trasparente	
380 mm	VS Vetro sabbaiato/Frosted glass VT Vetro trasparente/Transparent glass	a richiesta on request
670 mm	VS Vetro sabbaiato/Frosted glass VT Vetro trasparente/Transparent glass	a richiesta on request



LUNGHEZZE/LENGTH	WALL	VETRO/GLASS	DALI
399 mm	390 mm	VT Vetro trasparente/Transparent glass	a richiesta on request
960 mm	960 mm		
1260 mm	1260 mm		
1560 mm	1560 mm		

LONGLIGHT

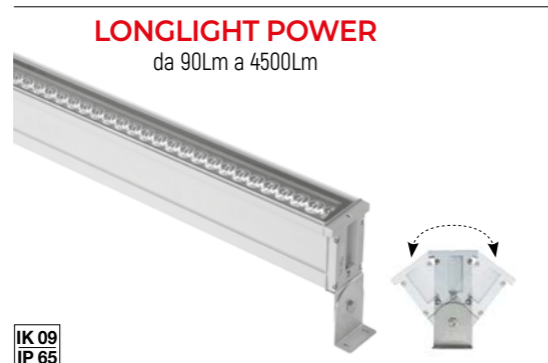

LUNGHEZZE/LENGTH	WALL	VETRO/GLASS
399 mm	3809 mm	VT Vetro trasparente/Transparent glass
960 mm	940 mm	
1260 mm	1240 mm	
1560 mm	1540 mm	



LUNGHEZZE/LENGTH	
360 mm	A richiesta connettori stagni IP68 per file continue max 30 apparecchi Upon request IP68 connector for continuous lines (max 30 lamps)
680 mm	(AD ESCLUSIONE DELLA VERSIONE 335 mm)
1227 mm	(EXCLUDING THE 335 mm VERSION)



LUNGHEZZE/LENGTH
606 mm
906 mm
1206 mm
1506 mm

LEDLINE



LUNGHEZZE/ LENGTH	MICRO	VETRO/GLASS	RGB
1050 mm	372 mm	VT Vetro trasparente/Transparent glass	a richiesta on request
2050 mm	572 mm		
3050 mm	1072 mm		
	1572 mm		
	2072 mm		

SURFACE LINEARI LINEARI DA TERRA E PARETE DA ESTERNO - WALL/SURFACE OUTDOOR LINEAR LIGHTS



CODICE CODE	DESCRIZIONE DESCRIPTION	FASCIO BEAM	COLORE FINISH		
E9054-P-LBC/LBN	LONGLIGHT MINI L.128mm - 4,5W 220Lm 350mA IP65 - VT	20°	INOX		LONGLIGHT MINI a richiesta - on request DIM 1+10V RGB IP65 VT Vetro trasparente/Transparent glass
E9050-P-LBC/LBN	LONGLIGHT MINI L.390mm - 8W 350Lm 350mA IP65 - VT	20°	INOX		
E9052-P-LBC/LBN	LONGLIGHT MINI L.390mm - 13,2W 1000Lm 24Vdc IP65 - VT	20°	INOX		
E9060-P-LBC/LBN	LONGLIGHT MINI L.690mm - 16W 700Lm 350mA IP65 - VT	20°	INOX		
E9062-P-LBC/LBN	LONGLIGHT MINI L.690mm - 25,4W 2100Lm 24Vdc IP65 - VT	20°	INOX		
E8941-PS-LBC/LBN-6	LONGLIGHT L.390mm - 8W 450Lm 350mA IP65 - VT	10°	ALS	 a richiesta on request IP65	
E8951PS-LBC/LBN18	LONGLIGHT L.960mm - 24W 1400Lm 350mA IP65 - VT	10°	ALS		
E8957PS-LBC/LBN24	LONGLIGHT L.1260mm - 32W 1800Lm 350mA IP65 - VT	10°	ALS		
E8958PS-LBC/LBN30	LONGLIGHT L.1560mm - 39W 2200Lm 350mA IP65 - VT	10°	ALS		
E8941-P-LBC/LBN-6	LONGLIGHT WALL L.380mm - 8W 450Lm 350mA IP65 - VT	10°	ALS	 a richiesta on request IP65	
E8951-P-LBC/LBN18	LONGLIGHT WALL L.940mm - 24W 1400Lm 350mA IP65 - VT	10°	ALS		
E8957-P-LBC/LBN24	LONGLIGHT WALL L.1240mm - 32W 1800Lm 350mA IP65 - VT	10°	ALS		
E8958-P-LBC/LBN30	LONGLIGHT WALL L.1540mm - 39W 2200Lm 350mA IP65 - VT	10°	ALS		
E8910-PS-LBC/LBN	LONGLIGHT POWER L.399mm - 4W 90Lm 12Vdc IP65 - VT DRIVER INTERNO - INCORPORATED DRIVER	DIFF	ALS	 a richiesta on request IP65	
E8930-PS-LBC/LBN	LONGLIGHT POWER L.960mm - 9W 250Lm 12Vdc IP65 - VT DRIVER INTERNO - INCORPORATED DRIVER	DIFF	ALS		
E8941-PS-LBC/LBN	LONGLIGHT POWER L.399mm - 16W 900Lm 24Vdc IP65 - VT	10°	ALS		
E8951-PS-LBC/LBN	LONGLIGHT POWER L.960mm - 46W 2400Lm 24Vdc IP65 - VT	10°	ALS		
E8957-PS-LBC/LBN	LONGLIGHT POWER L.1260mm - 60W 3500Lm 24Vdc IP65 - VT	10°	ALS		
E8958-PS-LBC/LBN	LONGLIGHT POWER L.1560mm - 74W 4500Lm 24Vdc IP65 - VT	10°	ALS		
E8910-P-LBC/LBN	LONGLIGHT POWER WALL L.380mm - 4W 90Lm 12Vdc IP65 - VT DRIVER INTERNO - INCORPORATED DRIVER	DIFF	ALS		
E8930-P-LBC/LBN	LONGLIGHT POWER WALL L.940mm - 9W 250Lm 12Vdc IP65 - VT DRIVER INTERNO - INCORPORATED DRIVER	DIFF	ALS		
E8941-P-LBC/LBN	LONGLIGHT POWER WALL L.380mm - 16W 900Lm 24Vdc IP65 - VT	10°	ALS	 a richiesta on request IP65	
E8951-P-LBC/LBN	LONGLIGHT POWER WALL L.940mm - 46W 2400Lm 24Vdc IP65 - VT	10°	ALS		
E8957-P-LBC/LBN	LONGLIGHT POWER WALL L.1240mm - 60W 3500Lm 24Vdc IP65 - VT	10°	ALS		
E8958-P-LBC/LBN	LONGLIGHT POWER WALL L.1540mm - 74W 4500Lm 24Vdc IP65 - VT	10°	ALS		

I CARATTERI ROSSI DEL CODICE INDICANO UNA VARIANTE - THE RED CHARACTERS IN A CODE INDICATE AN ALTERNATIVE

SURFACE LINEARI LINEARI DA TERRA E PARETE DA ESTERNO - WALL/SURFACE OUTDOOR LINEAR LIGHTS



CODICE CODE	DESCRIZIONE DESCRIPTION	FASCIO BEAM	COLORE FINISH	
E9030-LBC/LBN-25/35/EL	LONGLIGHT ECO L.360mm - 10W 750Lm 500mA IP65	25 - 35° EL 25x35°	ALS	
E9031-LBC/LBN-25/35/EL	LONGLIGHT ECO L.3605mm - 10W 600Lm 500mA IP65 - Con Palpebra/Whit Eyelid			
E9032-LBC/LBN-25/35/EL	LONGLIGHT ECO L.680mm - 20W 1500Lm 500mA IP65			
E9033-LBC/LBN-25/35/EL	LONGLIGHT ECO L.680mm - 20W 1200Lm 500mA IP65 - Con Palpebra/Whit Eyelid	25 - 35° EL 25x35°	ALS	
E9034-LBC/LBN-25/35/EL	LONGLIGHT ECO L.1027mm - 30W 23100Lm 500mA IP65			
E9035-LBC/LBN-25/35/EL	LONGLIGHT ECO L.1027mm - 30W 1800Lm 500mA IP65 - Con Palpebra/Whit Eyelid	25 - 35° EL 25x35°	ALS	
161	Kit di fissaggio n. 2 pezzi - Fixing kit n. 2 pieces - H 46 mm	-	-	
162	Kit di fissaggio n. 2 pezzi - Fixing kit n. 2 pieces - H 90 mm	-	-	
163	Kit di fissaggio n. 2 pezzi - Fixing kit n. 2 pieces - H 156 mm	-	-	
E9020-LBI	LONGLIGHT POSTER L.606mm - 32W 1700Lm 24Vdc IP65 IK09	10°	ALS	
E9021-LBI	LONGLIGHT POSTER L.906mm - 46W 2500Lm 24Vdc IP65 IK09	10°	ALS	
E9022-LBI	LONGLIGHT POSTER L.1206mm - 60W 3800Lm 24Vdc IP65 IK09	10°	ALS	
E9023-LBI	LONGLIGHT POSTER L.1506mm - 74W 4700Lm 24Vdc IP65 IK09	10°	ALS	
E961-LBC/LBN/LBI	LEDLINE MICRO L.1050mm - 14,4W 1100Lm 24Vdc IP68	120°	ALS	
E962-LBC/LBN/LBI	LEDLINE MICRO L.2050mm - 28,8W 2300Lm 24Vdc IP68	120°	ALS	
E963-LBC/LBN/LBI	LEDLINE MICRO L.3050mm - 43,2W 3400Lm 24Vdc IP68	120°	ALS	
E953-LBC/LBN/LBI	LEDLINE L.572mm - 14,4W 1100Lm 24Vdc IP68	120°	ALS	
E954-LBC/LBN/LBI	LEDLINE L.1072mm - 28,8W 2300Lm 24Vdc IP68	120°	ALS	
E955-LBC/LBN/LBI	LEDLINE L.1572mm - 43,2W 3400Lm 24Vdc IP68	120°	ALS	
E956-LBC/LBN/LBI	LEDLINE L.2072mm - 57,6W 3700Lm 24Vdc IP68	120°	ALS	

A richiesta connettori stagni IP68 per file continue max 30 apparecchi codice .../FC (AD ESCLUSIONE DELLA VERSIONE 33.5 cm)
On request in and out IP68 connection for continuous line max 30 fittings code .../FC (EXCLUDING THE 33.5 cm VERSION)

CON E SENZA PALPEBRA WITH AND WITHOUT EYELID

IP65

LONGLIGHT POSTER

LEDLINE MICRO

LEDLINE

a richiesta on request RGB IP68

100

JOGGER
2W - 140Lm



A richiesta - On request:



NEW GREEN XS
5,5W - 120Lm

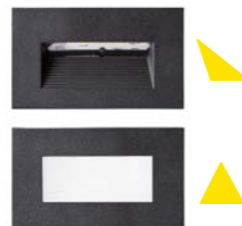

A richiesta - On request:



NEW
NEW GREEN XS - 24V
5,5W - 120Lm



SMALL-BLADE
2W - 150Lm

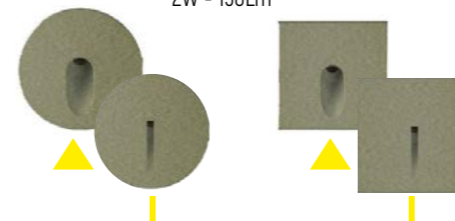

SMALL-BLADE LONG



A richiesta - On request:



200

NEW GREEN M
6W - 210Lm



A richiesta - On request:



300

NEW GREEN XL
9,5W - 420Lm



A richiesta - On request:



260 x 280

RIQUADRO
8,2 - 23,5W - 210 - 950Lm



A richiesta - On request:











INCASSI SEGNAPASSO PARETE DA ESTERNO - RECESSED STEPLIGHTS

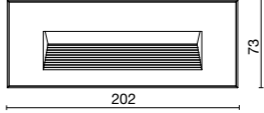

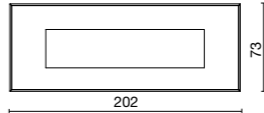
CODICE CODE	DESCRIZIONE DESCRIPTION	FASCIO BEAM	COLORE FINISH		
E912-LBC/LBN/LBL	JOGGER 2W 140Lm 220-240V IP65 - ASIMMETRICO - ASYMMETRIC	ASIMMETRICO	BI		<p>JOGGER</p>
<p>A richiesta: colorazioni corpo nero Ne - grigio Gr - RAL On request body colour black Ne - grey Gr - RAL</p>					
E5887/8/9-LBC/LBN	NEW GREEN XS 5,5W 100Lm 350mA IP65 IK07 - ASIMMETRICO - ASYMMETRIC	ASIMMETRICO	BI - NE - GR		<p>NEW GREEN XS</p>
E5887/8/9-LBC/LBN-V	NEW GREEN XS - VITI/SCREWS 5,5W 100Lm 350mA IP65 IK07 - ASIMMETRICO - ASYMMETRIC (viti antivandalo/vandal-proof screws)	ASIMMETRICO	BI - NE - GR		
E5890/91/92-LBC/LBN	NEW GREEN XS 5,5W 100Lm 350mA IP65 IK10 - SIMMETRICO - SYMMETRIC	SIMMETRICO	BI - NE - GR		
<p>A richiesta VERSIONE ANTIVANDALO Upon request VANDAL-PROOF VERSION</p>					
E5887/8/9-LBC/LBN-24	NEW GREEN XS - 24V 6W 210Lm 24V IP65 IK07 - ASIMMETRICO - ASYMMETRIC	ASIMMETRICO	BI - NE - GR		<p>NEW GREEN XS - 24V</p>
E5887/8/9-LBC/LBN-V-24	NEW GREEN XS - 24V - VITI/SCREWS 6W 210Lm 24V IP65 IK07 - ASIMMETRICO - ASYMMETRIC (viti antivandalo/vandal-proof screws)	ASIMMETRICO	BI - NE - GR		

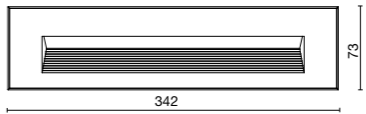
INCASSI SEGNAPASSO PARETE DA ESTERNO - RECESSED STEPLIGHTS

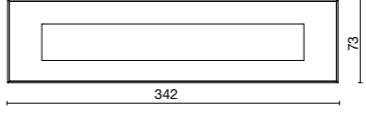

CODICE CODE	DESCRIZIONE DESCRIPTION	FASCIO BEAM	COLORE FINISH		
E5881/2/3-LBC/LBN	NEW GREEN M 6W 200Lm 350mA IP65 IK07 - ASIMMETRICO - ASYMMETRIC	ASIMMETRICO	BI - NE - GR		<p>NEW GREEN M</p> 
E5884/5/6-LBC/LBN	NEW GREEN M 6W 210Lm 350mA IP65 IK07 - SIMMETRICO - SYMMETRIC	SIMMETRICO	BI - NE - GR		
119-06			BR		
119-07	KIT Piastra compensazione telaio con fori per cassaforma 319200 KIT - Compensation trim with holes to fit recessed box 319200	-	NE		
119-19			GR		
320001	Scatola da immergere - Foro \varnothing 215 x 85mm Recessed box - Hole \varnothing 215 x 85mm	-	-	A richiesta VERSIONE ANTIVANDALO - On request VANDAL-PROOF VERSION	
E5875/6/7-LBC/LBN	NEW GREEN XL 9,5W 400Lm 350mA IP 65 IK 07 - ASIMMETRICO - ASYMMETRIC	ASIMMETRICO	BI - NE - GR		<p>NEW GREEN XL</p> 
E5878/79/80-LBC/LBN	NEW GREEN XL 9,5W 420Lm 350mA IP 65 IK 07 - SIMMETRICO - SYMMETRIC	SIMMETRICO	BI - NE - GR		
320000	ACCESSORI - ACCESSORIES Scatola da immergere - Foro \varnothing 355 x 85mm Recessed box - Hole \varnothing 355 x 85mm	-	-	A richiesta VERSIONE ANTIVANDALO - On request VANDAL-PROOF VERSION	

I CARATTERI ROSSI DEL CODICE INDICANO UNA VARIANTE - THE RED CHARACTERS IN A CODE INDICATE AN ALTERNATIVE

INCASSI SEGNAPASSO PARETE DA ESTERNO - RECESSED STEPLIGHTS



CODICE CODE	DESCRIZIONE DESCRIPTION	FASCIO BEAM	COLORE FINISH	
E5345-LBC/LBN	RIQUADRO 8,2W 220Lm 350mA IP65	ASIMMETRICO	BR	
E5346-LBC/LBN		ASIMMETRICO	NE	
E5347-LBC/LBN		ASIMMETRICO	GR	
E5313-LBC/LBN	RIQUADRO 23,5W 950Lm 350mA IP67 IK04	ASIMMETRICO	BR	
E5314-LBC/LBN		ASIMMETRICO	NE	
E5315-LBC/LBN		ASIMMETRICO	GR	
884-BR/NE/GR	ACCESSORI - ACCESSORIES Box montaggio parete - Optional box for surface application	-	BR - NE - GR	<p>884 Box montaggio parete</p> <p>a richiesta on request</p>
E909BR/NE-LBC/N/L/I	SMALL BLADE ROUND SCATOLA TONDA/ROUND BOX 2W 155Lm 500mA IP68 - ASIM	ASIMMETRICO	BR - NE - GA	
E909BR/NE-LBC/N/L/I-V	SMALL BLADE ROUND SCATOLA TONDA/ROUND BOX 2W 155Lm 500mA IP68 - ASIM - VITE	ASIMMETRICO	BR - NE - GA	
E951BR/NE-LBC/N/L/I	SMALL BLADE ROUND SCATOLA TONDA/ROUND BOX 2W 155Lm 500mA IP68 - SPOT	SPOT	BR - NE - GA	
E951BR/NE-LBC/N/L/I-V	SMALL BLADE ROUND SCATOLA TONDA/ROUND BOX 2W 155Lm 500mA IP68 - SPOT - VITE	SPOT	BR - NE - GA	
645626-1	Driver consigliato - Recommended driver ON-OFF 20W IP65 500mA	-	-	
E909BR/NE-Q-LBC/N/L/I	SMALL BLADE SQUARE SCATOLA TONDA/ROUND BOX 2W 155Lm 500mA IP68 - ASIM	ASIMMETRICO	BR - NE - GA	
E909BR/NE-Q-LBC/N/L/I-V	SMALL BLADE SQUARE SCATOLA TONDA/ROUND BOX 2W 155Lm 500mA IP68 - ASIM - VITE	ASIMMETRICO	BR - NE - GA	
E951BR/NE-Q-LBC/N/L/I	SMALL BLADE SQUARE SCATOLA TONDA/ROUND BOX 2W 155Lm 500mA IP68 - SPOT	SPOT	BR - NE - GA	
E909BR/NE-Q-LBC/N/L/I-V	SMALL BLADE SQUARE SCATOLA TONDA/ROUND BOX 2W 155Lm 500mA IP68 - SPOT - VITE	SPOT	BR - NE - GA	
645626-1	Driver consigliato - Recommended driver ON-OFF 20W IP65 500mA	-	-	
E909BR/NE-L-LBC/N/L/I	SMALL BLADE SQUARE LONG SCATOLA/BOX 503 2W 155Lm 500mA IP68 - AS. - VITE	ASIMMETRICO	BR - NE - GA	
E951BR/NE-L-LBC/N/L/I	SMALL BLADE SQUARE LONG SCATOLA/BOX 503 2W 155Lm 500mA IP68 - SPOT - VITE	SPOT	BR - NE - GA	

I CARATTERI ROSSI DEL CODICE INDICANO UNA VARIANTE - THE RED CHARACTERS IN A CODE INDICATE AN ALTERNATIVE

80

CUBE 80
12W - 1000Lm



100

NEOS
2W - 110Lm x LED

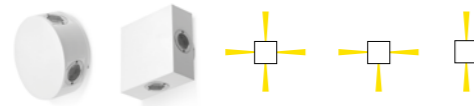

APPLY MINI
8,2W - 570Lm



120

CUBE 120
12W - 1000Lm



150

VARIANT 150
5,8/10,6W - 350/720Lm



NEW

RULED LINEAR IP PARETE
14W Fascio/Beam 75° - 1470Lm



200

VARIANT 200
11/22W - 650/1300Lm



NEW

RULED LINEAR IP PARETE
27W Fascio/Beam 75° - 2950Lm



NEW

FRISBEE WALL
16W - 850Lm

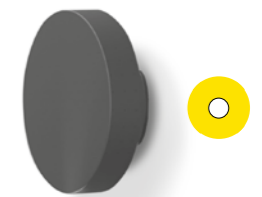

250

NEW

RULED LINEAR IP PARETE
40W Fascio/Beam 75° - 4400Lm



APPLY 1
9W - 600Lm



9W - 600Lm



APPLY 2

14W - 950Lm



300 - 350

VARIANT 300
8/15W - 380/750Lm



DECORATIVO PARETE - WALL DECORATIVE LIGHTS



CODICE CODE	DESCRIZIONE DESCRIPTION	FASCIO BEAM	COLORE FINISH	
3830LBC/LBN-75	RULED LINEAR IP54 PARETE 3 LED - L. 132mm - 14W 1470Lm 500mA IP65 MONO EMISSIONE - SINGLE SIDE EMISSION	75°	NE	
3845-LBC/LBN-75	RULED LINEAR IP54 PARETE 3 + 3 LED - L. 132mm - 27W 2950Lm 500mA IP65 BIEMISSIONE - DOUBLE SIDE EMISSION	75°	NE	
3835-LBC/LBN-75	RULED LINEAR IP54 PARETE 6 LED - L. 247mm - 27W 2950Lm 500mA IP65 MONO EMISSIONE - SINGLE SIDE EMISSION	75°	NE	
3850-LBC/LBN-75	RULED LINEAR IP54 PARETE 6 + 6 LED - L. 247mm - 52W 5900Lm 500mA IP65 BIEMISSIONE - DOUBLE SIDE EMISSION	75°	NE	
3840-LBC/LBN-75	RULED LINEAR IP54 PARETE 9 LED - L. 362mm - 40W 4400Lm 500mA IP65 MONO EMISSIONE - SINGLE SIDE EMISSION	75°	NE	
3855-LBC/LBN-75	RULED LINEAR IP54 PARETE 9 + 9 LED - L. 362mm - 79W 8850Lm 500mA IP65 BIEMISSIONE - DOUBLE SIDE EMISSION	75°	NE	

NEW RULED LINEAR IP PARETE



a richiesta - on request
fascio/beam 12° - 55° - AS - AE



DECORATIVO PARETE - WALL DECORATIVE LIGHTS



CODICE CODE	DESCRIZIONE DESCRIPTION	FASCIO BEAM	COLORE FINISH		
E5460-LBC/LBN	CUBE 80 14W 1000Lm 220-240V IP65 - MONO/BIEMISSIONE - MONO/DOUBLE SIDE EMISSION	da 10 a 85°	BR		
E5461-LBC/LBN		da 10 a 85°	NE		
E5450-LBC/LBN	CUBE 120 14W 1000Lm 220-240V IP65 - MONO/BIEMISSIONE - MONO/DOUBLE SIDE EMISSION	da 10 a 85°	BR		
E5451-LBC/LBN		da 10 a 85°	NE		
E5860T-LBC/LBN/LBL-10/30/45	NEOS T 2x2W 2x110Lm 500mA IP65 - 2 LED	10 - 25 - 40°	BR		
E5861T-LBC/LBN/LBL-10/30/45			NE		
E5862T-LBC/LBN/LBL-10/30/45			GR		
E5863T-LBC/LBN/LBL-10/30/45			BW		
E5864T-LBC/LBN/LBL-10/30/45	NEOS T 3x2W 3x110Lm 500mA IP65 - 3 LED	10 - 25 - 40°	BR		
E5865T-LBC/LBN/LBL-10/30/45			NE		
E5866T-LBC/LBN/LBL-10/30/45			GR		
E5867T-LBC/LBN/LBL-10/30/45			BW		
E5868T-LBC/LBN/LBL-10/30/45	NEOS T 4x2W 4x110Lm 500mA IP65 - 4 LED	10 - 25 - 40°	BR		
E5869T-LBC/LBN/LBL-10/30/45			NE		
E5870T-LBC/LBN/LBL-10/30/45			GR		
E5871T-LBC/LBN/LBL-10/30/45			BW		
E5860Q-LBC/LBN/LBL-10/30/45	NEOS Q 2x2W 2x110Lm 500mA IP65 - 2 LED	10 - 25 - 40°	BR		
E5861Q-LBC/LBN/LBL-10/30/45			NE		
E5862Q-LBC/LBN/LBL-10/30/45			GR		
E5863Q-LBC/LBN/LBL-10/30/45			BW		
E5864Q-LBC/LBN/LBL-10/30/45	NEOS Q 3x2W 3x110Lm 500mA IP65 - 3 LED	10 - 25 - 40°	BR		
E5865Q-LBC/LBN/LBL-10/30/45			NE		
E5866Q-LBC/LBN/LBL-10/30/45			GR		
E5867Q-LBC/LBN/LBL-10/30/45			BW		
E5868Q-LBC/LBN/LBL-10/30/45	NEOS Q 4x2W 4x110Lm 500mA IP65 - 4 LED	10 - 25 - 40°	BR		
E5869Q-LBC/LBN/LBL-10/30/45			NE		
E5870Q-LBC/LBN/LBL-10/30/45			GR		
E5871Q-LBC/LBN/LBL-10/30/45			BW		

NEW CUBE 80

NEW CUBE 120

NEOS T

NEOS Q

DECORATIVO PARETE - WALL DECORATIVE LIGHTS



CODICE CODE	DESCRIZIONE DESCRIPTION	FASCIO BEAM	COLORE FINISH		
E5850-LBC/LBN/LBI	VARIANT 150 5,8W 360Lm 350mA IP65 - MONO EMISSIONE - SINGLE SIDE EMISSION	30°	BR		
E5851-LBC/LBN/LBI			NE		
E5852-LBC/LBN/LBI			GR		
E5853-LBC/LBN/LBI	VARIANT 150 10,6W 720Lm 350mA IP65 - BIEMISSIONE - DOUBLE SIDE EMISSION	30°	BR		
E5854-LBC/LBN/LBI			NE		
E5855-LBC/LBN/LBI			GR		
E8830-LBC/LBN	VARIANT 200 20W 1000Lm 220-240V IP65 - MONO EMISSIONE - SINGLE SIDE EMISSION	-	BR		
E8831-LBC/LBN			NE		
E8832-LBC/LBN			GR		
E8820-LBC/LBN	VARIANT 200 40W 1950Lm 220-240V IP65 - BIEMISSIONE - DOUBLE SIDE EMISSION	-	BR		
E8821-LBC/LBN			NE		
E8822-LBC/LBN			GR		
E5810-LBC/LBN	VARIANT 300 8W 380Lm 350mA IP65 - MONO EMISSIONE - SINGLE SIDE EMISSION	30°	BR		
E5811-LBC/LBN			NE		
E5812-LBC/LBN			GR		
E5830-LBC/LBN	VARIANT 300 15W 750Lm 350mA IP65 - BIEMISSIONE - DOUBLE SIDE EMISSION	30°	BR		
E5831-LBC/LBN			NE		
E5832-LBC/LBN			GR		
a richiesta on request					

DECORATIVO PARETE - WALL DECORATIVE LIGHTS



CODICE CODE	DESCRIZIONE DESCRIPTION	FASCIO BEAM	COLORE FINISH		
E5676-LBC/LBN-P	FRISBEE WALL 16W 850Lm 500mA IP65	OMNI	BR		
E5677-LBC/LBN-P			NE		
E5678-LBC/LBN-P			GR		
E5679-LBC/LBN-P			BW		
					IP65 IK10
E8065-LBC/LBN	APPLY MINI 8,2W 570Lm 350mA IP65	-	NE		
E8066-LBC/LBN			GA		
E8067-LBC/LBN			BW		
P40-P-NE/GA/BW	ACCESSORI - ACCESSORIES Palo con basetta - Pole with base	-	NE - GA BW		
P40-NE/GA/BW	Palo da interrare - Pole to be buried	-	NE - GA BW		
					IP65 IK10
E8050-LBC/LBN/LBI	APPLY 1 9W 600Lm 24Vcc IP65 - MONO EMISSIONE - SINGLE SIDE EMISSION	-	NE		
					IP65 IK10
E8040-LBC/LBN/LBI	APPLY 2 9W 600Lm 24Vcc IP65 - MONO EMISSIONE - SINGLE SIDE EMISSION	-	NE		
					IP65 IK10
E8046-LBC/LBN/LBI	APPLY 2 14W x950Lm 24Vcc IP65 - BIEMISSIONE- DOUBLE SIDE EMISSION	-	NE		
					IP65 IK10

NEW FRISBEE WALL

APPLY MINI

APPLY 1

APPLY 2

PROIETTORI - PROJECTORS

IP 68

DRIVER ESTERNO/REMOTE DRIVER

IK 07
IP 67

DRIVER INTERNO/INCORPORATED DRIVER

IP 68

DRIVER ESTERNO/REMOTE DRIVER

IK 09
IP 66

DRIVER INTERNO/INCORPORATED DRIVER



30

SPOT INOX

25W Fascio/Beam 10° - 170Lm



SPOT 35

3W Fascio/Beam 20 - 46° - 200Lm



50

SPOT 50

8W Fascio/Beam 12 - 18 - 34° - 744Lm



SPOT 7

8W Fascio/Beam 10° - 500Lm



70

SPOT 70

16,4W Fascio/Beam 16 - 30 - 56° - 1280Lm



90

SPOT 90

Fascio/Beam 19 - 38 - 56° - 3020Lm



IK 09
IP 66

REEF MICRO

10W Fascio/Beam 10 - 25° - 770Lm



150

REEF MINI

35W Fascio/Beam 15 - 30 - 60° - 3300Lm



NEW

IP 65

RULED LINEAR IP PROIETTORE

14W Fascio/Beam 75° - 1470Lm



210 - 250

REEF

44W Fascio/Beam 15 - 25 - 40° - 5500Lm

REEF RGB

15x1,2W Fascio/Beam 10 - 30 - 45°



NEW

RULED LINEAR IP PROIETTORE

27W Fascio/Beam 75° - 2950Lm



360

NEW





RULED LINEAR IP PROIETTORE

40W Fascio/Beam 75° - 4400Lm

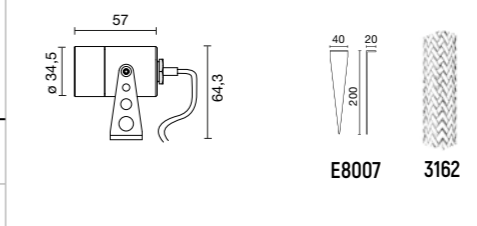
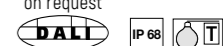
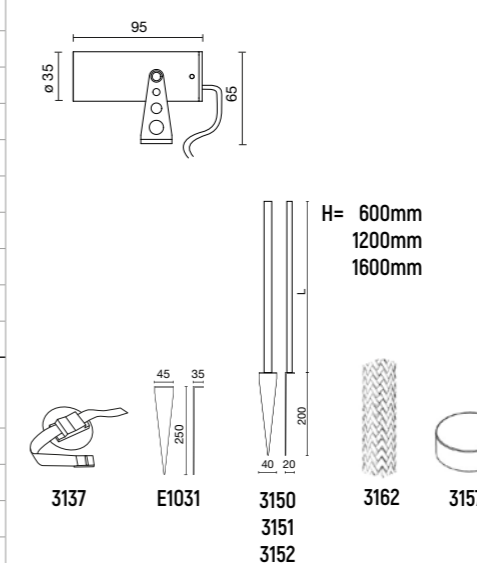

PROIETTORI - PROJECTORS SISTEMA SPOT ESTERNO IP 67 - IP67 OUTDOOR SPOT SYSTEM

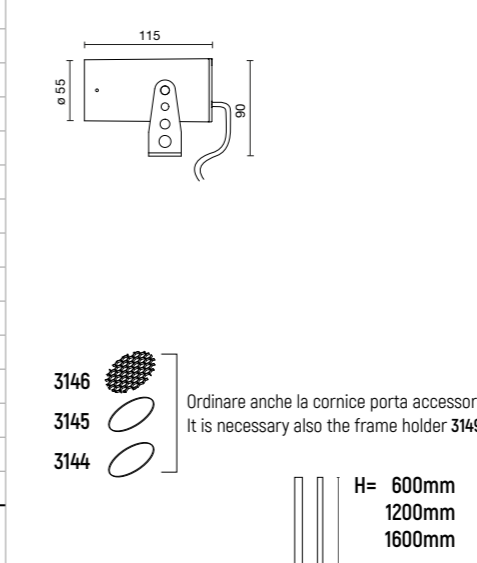

CODICE CODE	DESCRIZIONE DESCRIPTION	FASCIO BEAM	COLORE FINISH	
E918-LBC/LBN	SPOT INOX 2,5W 170Lm	10°	INOX	 <p>SPOT INOX</p> <p>a richiesta on request</p> 
E8007	ACCESSORI - ACCESSORIES Picchetto da interrare/Ground spike	-	-	
3162	Copertura protezione cavo di alimentazione, acciaio flessibile - protective covering of power cable in flexible stainless steel - L.500mm	-	INOX	
E67910-LBC/LBN-S	SPOT 35 3W 200Lm 200mA IP67 IK07	20°	GR	 <p>SPOT 35</p> <p>H= 600mm 1200mm 1600mm</p> <p>a richiesta on request</p> 
E67911-LBC/LBN-S			NE	
E67912-LBC/LBN-S			BW	
E67913-LBC/LBN-S			VE	
E67914-LBC/LBN-S			CORTEN	
E67910-LBC/LBN-FL	SPOT 35 3W 200Lm 200mA IP67 IK07	46°	GR	
E67911-LBC/LBN-FL			NE	
E67912-LBC/LBN-FL			BW	
E67913-LBC/LBN-FL			VE	
E67914-LBC/LBN-FL			CORTEN	
3137	ACCESSORI - ACCESSORIES Cinghia di fissaggio ai rami - Fastening strip for three branch use	-	-	
E1031	Picchetto inox da interrare - Spike for ground installation	-	-	
3162	Copertura protezione cavo di alimentazione, acciaio flessibile - protective covering of power cable in flexible stainless steel - L.500mm	-	INOX	
3150-GR/NE/BW/VE/CO	Asta con picchetto INOX - Rod with spike INOX - 600mm	-	GR - NE - BW - VE - CO	
3151-GR/NE/BW/VE/CO	Asta con picchetto INOX - Rod with spike INOX - 1200mm	-	GR - NE - BW - VE - CO	
3152-GR/NE/BW/VE/CO	Asta con picchetto INOX - Rod with spike INOX - 1600mm	-	GR - NE - BW - VE - CO	
3157-GR/NE/BW/VE/CO	Basetta - Base - D. 60mm - H. 42mm	-	GR - NE - BW - VE - CO	
E67900-LBC/LBN-S	SPOT 50 8W 760Lm 200mA IP67 IK07	12°	GR	 <p>SPOT 50</p> <p>H= 600mm 1200mm 1600mm</p> <p>Ordinare anche la cornice porta accessori 3149-... It is necessary also the frame holder 3149-...</p> <p>a richiesta on request</p> 
E67901-LBC/LBN-S			NE	
E67902-LBC/LBN-S			BW	
E67903-LBC/LBN-S			VE	
E67904-LBC/LBN-S			CORTEN	
E67900-LBC/LBN-FL	SPOT 50 8W 760Lm 200mA IP67 IK07	18°	GR	
E67901-LBC/LBN-FL			NE	
E67902-LBC/LBN-FL			BW	
E67903-LBC/LBN-FL			VE	
E67904-LBC/LBN-FL			CORTEN	
E67900-LBC/LBN-WF	SPOT 50 8W 760Lm 200mA IP67 IK07	34°	GR	
E67901-LBC/LBN-WF			NE	
E67902-LBC/LBN-WF			BW	
E67903-LBC/LBN-WF			VE	
E67904-LBC/LBN-WF			CORTEN	
3137	ACCESSORI - ACCESSORIES Cinghia di fissaggio ai rami - Fastening strip for three branch use	-	-	
E1031	Picchetto inox da interrare - Spike for ground installation	-	-	
3162	Copertura protezione cavo di alimentazione, acciaio flessibile - protective covering of power cable in flexible stainless steel - L.500mm	-	INOX	
3150-GR/NE/BW/VE/CO	Asta con picchetto INOX - Rod with spike INOX 600mm	-	GR - NE - BW - VE - CO	
3151-GR/NE/BW/VE/CO	Asta con picchetto INOX - Rod with spike INOX 1200mm	-	GR - NE - BW - VE - CO	
3152-GR/NE/BW/VE/CO	Asta con picchetto INOX - Rod with spike INOX - 1600mm	-	GR - NE - BW - VE - CO	
3147-GR/NE/BW/VE/CO	Cilindro di schermatura - Shielding cylinder	-	GR - NE - BW - VE - CO	
3148-GR/NE/BW/VE/CO	Cilindro di schermatura - Shielding cylinder 45°	-	GR - NE - BW - VE - CO	
3149-GR/NE/BW/VE/CO	Cornice per accessori - Frame holder for accessory	-	GR - NE - BW - VE - CO	
3156-GR/NE/BW/VE/CO	Basetta - Base - D. 100mm - H. 30mm	-	GR - NE - BW - VE - CO	
3146	Griglia alveolare - Alveolar grid	-	-	
3145	Lente ellittica - Elliptical lens	-	-	
3144	Lente diffondente - Wide flood	-	-	

PROIETTORI - PROJECTORS SISTEMA SPOT ESTERNO IP 67 - IP67 OUTDOOR SPOT SYSTEM



CODICE CODE	DESCRIZIONE DESCRIPTION	FASCIO BEAM	COLORE FINISH
E67886-LBC/LBN-S	SPOT 70 16,4W 1300Lm 400mA IP67 IK07	19°	GR
E67887-LBC/LBN-S			NE
E67888-LBC/LBN-S			BW
E67889-LBC/LBN-S			VE
E67890-LBC/LBN-S			CORTEN
E67886-LBC/LBN-FL	SPOT 70 16,4W 1300Lm 400mA IP67 IK07	38°	GR
E67887-LBC/LBN-FL			NE
E67888-LBC/LBN-FL			BW
E67889-LBC/LBN-FL			VE
E67890-LBC/LBN-FL			CORTEN
E67886-LBC/LBN-WF	SPOT 70 16,4W 1300Lm 400mA IP67 IK07	56°	GR
E67887-LBC/LBN-WF			NE
E67888-LBC/LBN-WF			BW
E67889-LBC/LBN-WF			VE
E67890-LBC/LBN-WF			CORTEN
3137	ACCESSORI - ACCESSORIES Cinghia di fissaggio ai rami - Fastening strip for three branch use	-	-
E1031	Picchetto inox da interrare - Spike for ground installation	-	-
3162	Copertura protezione cavo di alimentazione, acciaio flessibile - protective covering of power cable in flexible stainless steel - L.500mm	-	INOX
3150-GR/NE/BW/VE/CO	Asta con picchetto - Rod with spike INOX 600mm	-	GR - NE - BW - VE - CO
3151-GR/NE/BW/VE/CO	Asta con picchetto - Rod with spike INOX 1200mm	-	GR - NE - BW - VE - CO
3152-GR/NE/BW/VE/CO	Asta con picchetto INOX - Rod with spike INOX - 1600mm	-	GR - NE - BW - VE - CO
406207	Palo da interrare - Pole to be buried - 3000mm (2500mm fuori terra - above ground) NEW	-	NE
406259			GR
406208			BW
E1040-GR			GR
E1040-NE	NE		
E1040-BW	Kit attacco palo - Pole bracket kit NEW	-	BW
E1040-VE			VE
E1040-CO			CO
3134-GR/NE/BW/VE/CO	Cilindro di schermatura - Shielding cylinder	-	GR - NE - BW - VE - CO
3133-GR/NE/BW/VE/CO	Cilindro di schermatura - Shielding cylinder 45°	-	GR - NE - BW - VE - CO
3136-GR/NE/BW/VE/CO	Cornice per accessori - Frame holder for accessory	-	GR - NE - BW - VE - CO
3156-GR/NE/BW/VE/CO	Basetta - Base - D. 100mm - H. 30mm	-	GR - NE - BW - VE - CO
3131	Griglia alveolare - Alveolar grid	-	-
3129	Lente ellittica - Elliptical lens	-	-
3130	Lente diffondente - Wide flood	-	-

SPOT 70

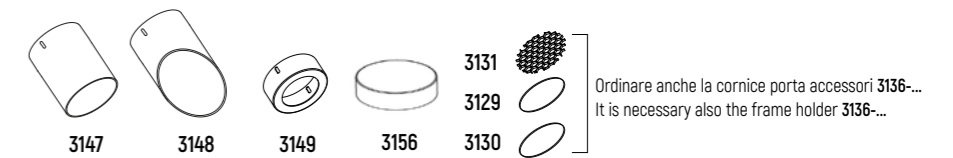
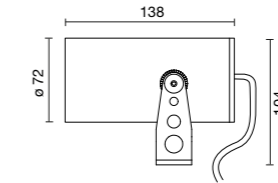

Ordinare anche la cornice porta accessori 3136-...
It is necessary also the frame holder 3136-...

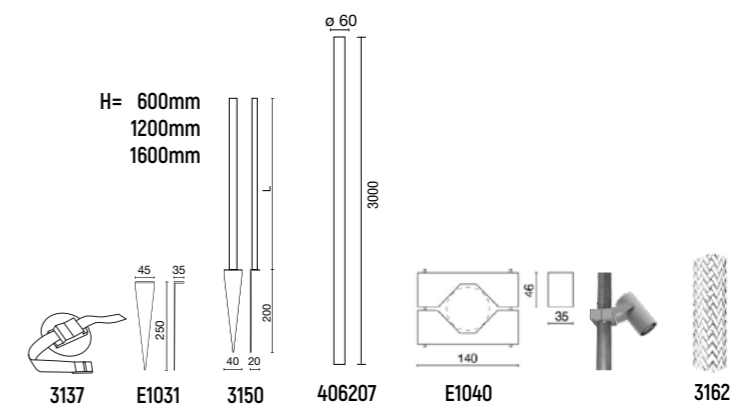

A richiesta - on request: 24Vdc

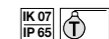

PROIETTORI - PROJECTORS SISTEMA SPOT ESTERNO IP 67 - IP67 OUTDOOR SPOT SYSTEM



CODICE CODE	DESCRIZIONE DESCRIPTION	FASCIO BEAM	COLORE FINISH
E67895-LBC/LBN-S	SPOT 90 27W 2870Lm 700mA IP67 IK07	16°	GR
E67896-LBC/LBN-S			NE
E67897-LBC/LBN-S			BW
E67898-LBC/LBN-S			VE
E67899-LBC/LBN-S			CORTEN
E67895-LBC/LBN-FL	SPOT 90 27W 2873Lm 700mA IP67 IK07	30°	GR
E67896-LBC/LBN-FL			NE
E67897-LBC/LBN-FL			BW
E67898-LBC/LBN-FL			VE
E67899-LBC/LBN-S			CORTEN
E67895-LBC/LBN-WF	SPOT 90 27W 2873Lm 700mA IP67 IK07	56°	GR
E67896-LBC/LBN-WF			NE
E67897-LBC/LBN-WF			BW
E67898-LBC/LBN-WF			VE
E67899-LBC/LBN-WF			CORTEN
3137	ACCESSORI - ACCESSORIES Cinghia di fissaggio ai rami - Fastening strip for three branch use	-	-
E1031	Picchetto inox da interrare - Spike for ground installation	-	-
406207	Palo da interrare - Pole to be buried - 3000mm (2500mm fuori terra - above ground) NEW	-	NE
406259			GR
406208			BW
E1040-GR			GR
E1040-NE	Kit attacco palo - Pole bracket kit NEW	-	NE
E1040-BW			BW
E1040-VE			VE
E1040-CO			CO
3162	Copertura protezione cavo di alimentazione, acciaio flessibile - protective covering of power cable in flexible stainless steel - L.500mm	-	INOX
3141-GR/NE/BW/VE/CO	Cilindro di schermatura - Shielding cylinder	-	GR - NE - BW - VE - CO
3142-GR/NE/BW/VE/CO	Cilindro di schermatura - Shielding cylinder 45°	-	GR - NE - BW - VE - CO
3143-GR/NE/BW/VE/CO	Cornice per accessori - Frame holder for accessory	-	GR - NE - BW - VE - CO
3156-GR/NE/BW/VE/CO	Basetta - Base - D. 100mm - H. 30mm	-	GR - NE - BW - VE - CO
3140	Griglia alveolare - Alveolar grid	-	GR - NE - BW - VE - CO
3139	Lente ellittica - Elliptical lens	-	-
3138	Lente diffondente - Wide flood	-	-
E921-LBC/LBI/LBL	SPOT 7 8W 500Lm 350mA IP68	10°	GR
E8008	ACCESSORI - ACCESSORIES Basetta con alimentatore - Base plate with transformer	-	GR
E1031	Picchetto inox da interrare - Spike for ground installation	-	INOX
3162	Copertura protezione cavo di alimentazione, acciaio flessibile - protective covering of power cable in flexible stainless steel - L.500mm	-	INOX
E8004	Picchetto per basetta - Spike for base plate	-	-
645732	Driver consigliato - Recommended driver ON-OFF IP20 2,5/42W - 150/1050mA	-	-

SPOT 90

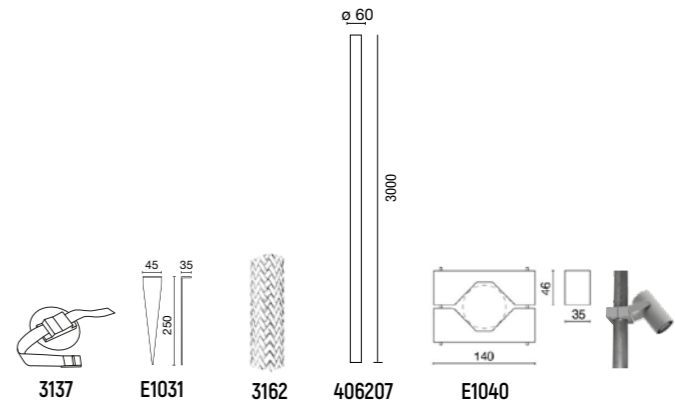
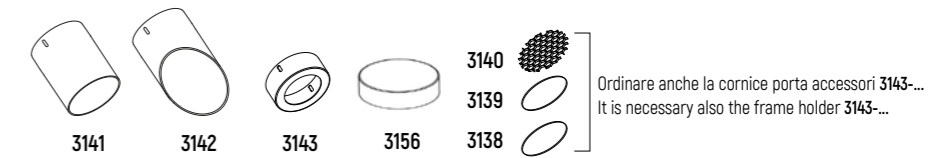
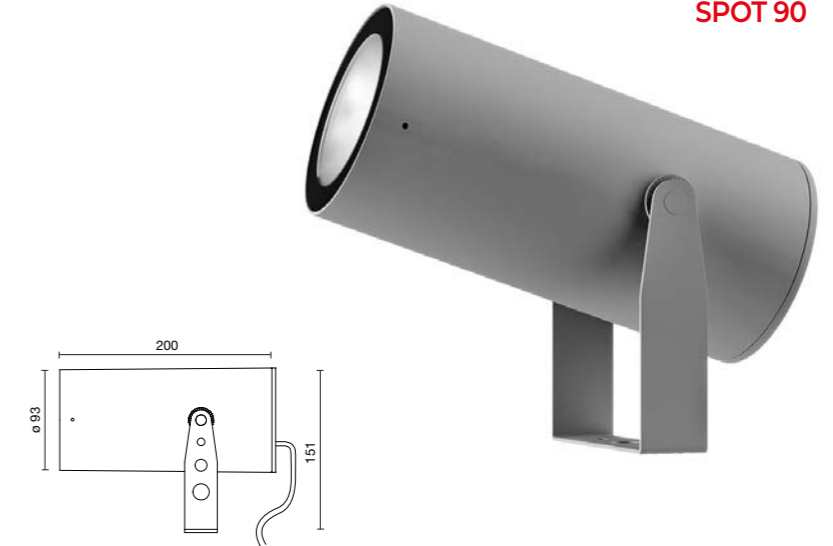

A richiesta - on request: 24Vdc

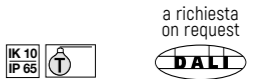

SPOT 7

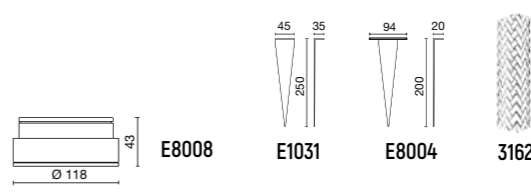
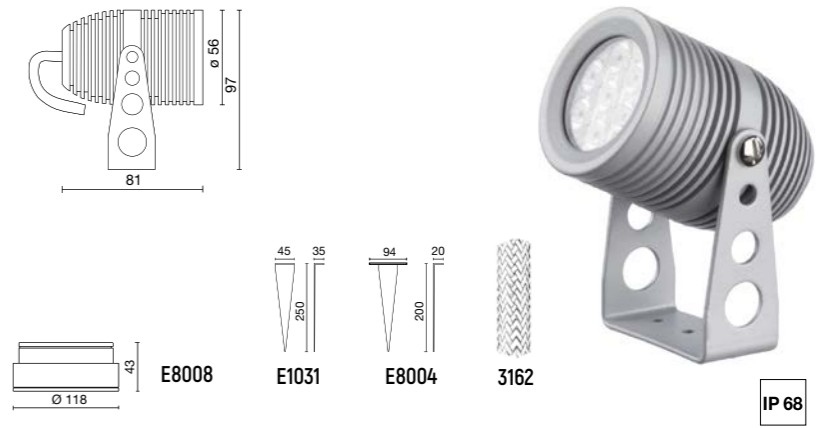

IP 68

PROIETTORI - PROJECTORS SISTEMA SPOT ESTERNO IP 67 - IP67 OUTDOOR SPOT SYSTEM



CODICE CODE	DESCRIZIONE DESCRIPTION	FASCIO BEAM	COLORE FINISH		
E1085-LBC/LBN-10/25	REEF MICRO 10W 770Lm 250mA IP66 IK06	10 - 25°	BR		
E1086-LBC/LBN-10/25			NE		
E1087-LBC/LBN-10/25			GR		
E1035	ACCESSORI - ACCESSORIES Palpebra - Eyelid	-	BR		
E1036	Palpebra - Eyelid	-	NE		
E1037	Palpebra - Eyelid	-	GR		
E1031	Picchetto - Spike INOX	-	INOX		
3162	Copertura protezione cavo di alimentazione, acciaio flessibile - protective covering of power cable in flexible stainless steel - L.500mm	-	INOX		
E1080-LBC/LBN	REEF MINI 35W 3300Lm 850mA IP66 IK09	15°	BR		
E1081-LBC/LBN			NE		
E1082-LBC/LBN			GR		
E1074-LBC/LBN	REEF MINI 35W 3300Lm 850mA IP66 IK09	30°	BR		
E1075-LBC/LBN			NE		
E1076-LBC/LBN			GR		
E1077-LBC/LBN	REEF MINI 35W 3300Lm 850mA IP66 IK09	60°	BR		
E1078-LBC/LBN			NE		
E1079-LBC/LBN			GR		
E1067	ACCESSORI - ACCESSORIES Palpebra - Eyelid	-	BR		
E1068	Palpebra - Eyelid	-	NE		
E1069	Palpebra - Eyelid	-	GR		
E1031	Picchetto - Spike INOX	-	INOX		
3162	Copertura protezione cavo di alimentazione, acciaio flessibile - protective covering of power cable in flexible stainless steel - L.500mm	-	INOX		
E1070	Aletta singola - Single flap	-	BR		
E1071	Aletta singola - Single flap	-	NE		
E1072	Aletta singola - Single flap	-	GR		
E1038	Kit attacco palo - Pole bracket kit	-	NE		
E1039	Kit attacco palo - Pole bracket kit	-	GR		
E1027-LBC/LBN-15/25/40	REEF 44W 5500Lm 1150mA IP66 IK06	15 - 25 - 40°	NE		
E1028-LBC/LBN-15/25/40			GR		
E1010-RGB-10/30/45	REEF RGB 15x1,2W 350mA IP66 IK06 - RGB	10 - 30 - 45°	NE		
E1011-RGB-10/30/45			GR		
E1020	ACCESSORI - ACCESSORIES Palpebra - Eyelid	-	NE		
E1021	Palpebra - Eyelid	-	GR		
E1031	Picchetto - Spike INOX	-	INOX		
3162	Copertura protezione cavo di alimentazione, acciaio flessibile - protective covering of power cable in flexible stainless steel - L.500mm	-	INOX		
E1025	Aletta singola - Single flap	-	NE		
E1026	Aletta singola - Single flap	-	GR		
E1038	Kit attacco palo - Pole bracket kit	-	NE		
E1039	Kit attacco palo - Pole bracket kit	-	GR		

REEF MICRO

REEF MINI

REEF

a richiesta on request
IK 09 IP 66

PROIETTORI - PROJECTORS



CODICE CODE	DESCRIZIONE DESCRIPTION	FASCIO BEAM	COLORE FINISH	
3915-LBC/ LBN -75	RULED LINEAR IP PROIETTORE 3 LED - L. 132mm - 14W 1470Lm 500mA IP65	75°	NE	<div style="display: flex; align-items: center;"> <div style="margin-right: 20px;"> </div> <div style="text-align: right;"> <p>NEW RULED LINEAR IP PROIETTORE</p> </div> </div>
3920-LBC/ LBN -75	RULED LINEAR IP PROIETTORE 6 LED - L. 247mm - 27W 2950Lm 500mA IP65	75°	NE	<div style="display: flex; align-items: center;"> <div style="margin-right: 20px;"> </div> <div style="text-align: right;"> </div> </div>
3825-LBC/ LBN -75	RULED LINEAR IP PROIETTORE 9 LED - L. 362mm - 40W 4400Lm 500mA IP65	75°	NE	<div style="display: flex; align-items: center;"> <div style="margin-right: 20px;"> </div> <div style="text-align: right;"> </div> </div>
E1031-E	<p>ACCESSORI - ACCESSORIES Picchetto da interrare - Pike for ground installation</p>	-	NE	<div style="display: flex; align-items: center;"> <div style="margin-right: 20px;"> </div> <div style="text-align: right;"> </div> </div> <div style="display: flex; justify-content: space-between; align-items: center; margin-top: 10px;"> E1031-E <div style="text-align: right;"> <p>a richiesta on request</p> </div> </div>

**PARETE - PLAFONE
OUTDOOR WALL LIGHTS**

80

**TONDO
MINI MONO**
13,5W - 1200Lm
MINI DOUBLE
6-14,7W - 200-1400Lm



**QUADRO
MINI MONO**
13,5W - 1200Lm
MINI DOUBLE
6-14,7W - 200-1400Lm



ELLE PARETE XS
14W - 1900Lm



105

MONOLIGHT 105
14,9W - 1000Lm
DOUBLELIGHT 105
27,8W - 2100Lm



SOLARIS MINI
14,4W - 1100Lm

FISSO
FIX

ORIENTABILE
ADJUSTABLE

140

MONOLIGHT 140
20W - 2000Lm
DOUBLELIGHT 140
37W - 3500/4100Lm



QUADRO MONO
41W - 4900Lm
QUADRO DOUBLE
78W - 9300Lm



175

MONOLIGHT 175
40W - 5000Lm
DOUBLELIGHT 175
76W - 9000Lm



200

SOLARIS
44W - 5000Lm

FISSO
FIX

ELLE PARETE XL
64W - 7500Lm

ORIENTABILE
ADJUSTABLE

**PALO E ACCESSORI MONTAGGIO
POLE AND MOUNTING ACCESSORIES**



ATTACCO PALO ADATTO PER/SUITABLE FOR:

MONOLIGHT
175

DOUBLELIGHT
175

QUADRO MONO

QUADRO
DOUBLE



PALO QUADRO ADATTO PER/SUITABLE FOR:

Adatto per tutte le versioni
Suitable for all versions
QUADRO MONO

PARETE - PLAFONE - OUTDOOR WALL LIGHTS



CODICE CODE	DESCRIZIONE DESCRIPTION	FASCIO BEAM	COLORE FINISH		
E4900-LBC/LBN-M	MINI MONO TONDO 13,5W 1200Lm 350mA IP65 - MONOEMISSIONE - SINGLE SIDE EMISSION	40°	BR		
E4901-LBC/LBN-M			NE		
E4902-LBC/LBN-M			GR		
MINI MONO TONDO					
E4900-LBC/LBN-1L	MINI DOUBLE TONDO 14,7W 1400Lm 350mA IP65 - 1 FASCIO STRETTO/NARROW BEAM	5 + 40°	BR		
E4901-LBC/LBN-1L			NE		
E4902-LBC/LBN-1L			GR		
MINI DOUBLE TONDO					
E4905-LBC/LBN-2L	MINI DOUBLE TONDO 6W 200Lm 350mA IP65 - 2 FASCI STRETTI/NARROW BEAMS	5 + 5°	BR		
E4906-LBC/LBN-2L			NE		
E4907-LBC/LBN-2L			GR		
MINI DOUBLE TONDO					
E4910-LBC/LBN-M	MINI MONO QUADRO 13,5W 1200Lm 350mA IP65 - MONOEMISSIONE - SINGLE SIDE EMISSION	40°	BR		
E4911-LBC/LBN-M			NE		
E4912-LBC/LBN-M			GR		
MINI MONO QUADRO					
E4910-LBC/LBN-1L	MINI DOUBLE TONDO 14,7W 1400Lm 350mA IP65 - 1 FASCIO STRETTO/NARROW BEAM	5 + 40°	BR		
E4911-LBC/LBN-1L			NE		
E4912-LBC/LBN-1L			GR		
MINI DOUBLE QUADRO					
E4915-LBC/LBN-2L	MINI DOUBLE TONDO 6W 200Lm 350mA IP65 - 2 FASCI STRETTI/NARROW BEAMS	5 + 5°	BR		
E4916-LBC/LBN-2L			NE		
E4917-LBC/LBN-2L			GR		
MINI DOUBLE QUADRO					

I CARATTERI ROSSI DEL CODICE INDICANO UNA VARIANTE - THE RED CHARACTERS IN A CODE INDICATE AN ALTERNATIVE

PARETE - PLAFONE - OUTDOOR WALL LIGHTS







CODICE CODE	DESCRIZIONE DESCRIPTION	FASCIO BEAM	COLORE FINISH			
E5550C-LBC/LBN-15/24/40	MONOLIGHT 105 14,9W 1000Lm 350mA IP65 - MONOEMISSIONE - SINGLE SIDE EMISSION	15 - 24 - 40°	BR			
E5551C-LBC/LBN-15/24/40			NE			
E5552C-LBC/LBN-15/24/40			GR			
E5590-LBC/LBN-16/24/40	MONOLIGHT 140 20W 2100Lm 500mA IP65 - MONOEMISSIONE SIMMETRICA - SINGLE SIDE EMISSION SYMMETRIC	15 - 24 - 40°	BR			
E5591-LBC/LBN-16/24/40			NE			
E5592-LBC/LBN-16/24/40			GR			
E5590-LBC/LBN-AS	MONOLIGHT 140 20W 1800Lm - MONOEMISSIONE ASIMMETRICA - SINGLE SIDE EMISSION ASYMMETRIC	ASIM	BR			
E5591-LBC/LBN-AS			NE			
E5592-LBC/LBN-AS			GR			
E5680-LBC/LBN-16/25/40	MONOLIGHT 175 40W 5000Lm 1050mA IP65 - MONOEMISSIONE - SINGLE SIDE EMISSION	15 - 25 - 40°	BR			
E5681-LBC/LBN-16/25/40			NE			
E5682-LBC/LBN-16/25/40			GR			
E5553C-LBC/LBN-15/24/40	DOUBLELIGHT 105 26,6W 2100Lm 500mA IP65 - BIEMISSIONE - DOUBLE SIDE EMISSION	15 - 24 - 40°	BR			
E5554C-LBC/LBN-15/24/40			NE			
E5555C-LBC/LBN-15/24/40			GR			
E5593-LBC/LBN-16/24/40	DOUBLELIGHT 140 37W 4100Lm 500mA IP65 - BIEMISSIONE - DOUBLE SIDE EMISSION	16 - 24 - 40°	BR			
E5594-LBC/LBN-16/24/40			NE			
E5595-LBC/LBN-16/24/40			GR			
E5593-LBC/LBN-AS	DOUBLELIGHT 140 37W 3500Lm 500mA IP65 - BIEMISSIONE ASIMMETRICA - DOUBLE SIDE ASYMMETRIC	ASIM	BR			
E5594-LBC/LBN-AS			NE			
E5595-LBC/LBN-AS			GR			
E5683-LBC/LBN-16/25/40	DOUBLELIGHT 175 76W 9000Lm 1050mA IP65 - BIEMISSIONE - DOUBLE SIDE EMISSION	15 - 25 - 40°	BR			
E5684-LBC/LBN-16/25/40			NE			
E5685-LBC/LBN-16/25/40			GR			

I CARATTERI ROSSI DEL CODICE INDICANO UNA VARIANTE - THE RED CHARACTERS IN A CODE INDICATE AN ALTERNATIVE

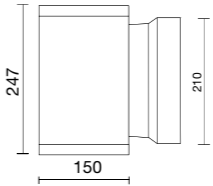
PARETE - PLAFONE - OUTDOOR WALL LIGHTS

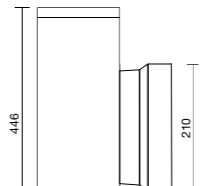
OUTSIDE

CODICE CODE	DESCRIZIONE DESCRIPTION	FASCIO BEAM	COLORE FINISH		
E5375-LBC/LBN-15/40/60	QUADRO MONO 41W 4900Lm 1050mA IP65 - MONOEMISSIONE - SINGLE SIDE EMISSION	15 - 40 - 60°	BR		<p>QUADRO MONO</p>  <p>a richiesta on request</p> 
E5376-LBC/LBN-15/40/60	QUADRO MONO 41W 4900Lm 1050mA IP65 - MONOEMISSIONE - SINGLE SIDE EMISSION	15 - 40 - 60°	NE		
E5377-LBC/LBN-15/40/60	QUADRO MONO 41W 4900Lm 1050mA IP65 - MONOEMISSIONE - SINGLE SIDE EMISSION	15 - 40 - 60°	GR		
E5381-LBC/LBN-15/40/60	QUADRO DOUBLE 78W 9500Lm 1050mA IP65 - BIEMISSIONE - DOUBLE SIDE EMISSION	15 - 40 - 60°	BR		<p>QUADRO DOUBLE</p>  <p>IP65</p>
E5382-LBC/LBN-15/40/60	QUADRO DOUBLE 78W 9500Lm 1050mA IP65 - BIEMISSIONE - DOUBLE SIDE EMISSION	15 - 40 - 60°	NE		
E5383-LBC/LBN-15/40/60	QUADRO DOUBLE 78W 9500Lm 1050mA IP65 - BIEMISSIONE - DOUBLE SIDE EMISSION	15 - 40 - 60°	GR		

PARETE - PLAFONE - OUTDOOR WALL LIGHTS











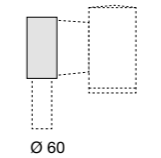

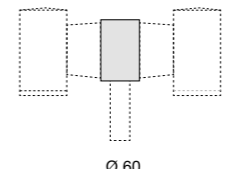

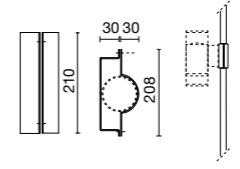
CODICE CODE	DESCRIZIONE DESCRIPTION	FASCIO BEAM	COLORE FINISH			
67960-LBC/LBN	SOLARIS MINI 19,3W 1500Lm 450mA IP65 IK06 - SIMMETRICA ORIENTABILE - SYMMETRIC-ADJUSTABLE	SIM	BR			
67961-LBC/LBN			NE			
67962-LBC/LBN			GR			
67966-LBC/LBN	SOLARIS MINI 19,3W 1350Lm 450mA IP65 IK06 - ASIMMETRICA - ASYMMETRIC	ASIM	BR			
67967-LBC/LBN			NE			
67968-LBC/LBN			GR			
67966-LBC/LBN-F	SOLARIS MINI FISSO 19,3W 1350Lm 450mA IP65 IK06 - ASIMMETRICA - ASYMMETRIC	ASIM	BR			
67967-LBC/LBN-F			NE			
67968-LBC/LBN-F			GR			
67950-LBC/LBN-B	SOLARIS 38W 5000Lm 525mA IP65 IK06 - SIMMETRICA ORIENTABILE - SYMMETRIC-ADJUSTABLE NEW Vetro serigrafato in colore bianco - Silk-screened glass White color	ASIM	BR			
67950-LBC/LBN			BR			
67951-LBC/LBN			NE			
67952-LBC/LBN			GR			
67950-LBC/LBN-F-B	SOLARIS FISSO 38W 5000Lm 525mA IP65 IK06 - ASIMMETRICA - ASYMMETRIC NEW Vetro serigrafato in colore bianco - Silk-screened glass White color	ASIM	BR			
67950-LBC/LBN-F			BR			
67951-LBC/LBN-F			NE			
67952-LBC/LBN-F			GR			
E4083-LBC/LBN	ELLE PARETE XS 14W 1900Lm 350mA IP65 - SIMMETRICA - SYMMETRIC	SIM	GR			
E4084-LBC/LBN			NE			
E4085-LBC/LBN			BW			
E4083AS-LBC/LBN	ELLE PARETE XS 14W 1900Lm 350mA IP65 - ASIMMETRICA - ASYMMETRIC	ASIM	GR			
E4084AS-LBC/LBN			NE			
E4085AS-LBC/LBN			BW			
E4111-LBC/LBN	ELLE PARETE XL 64W 7500Lm 800mA IP65 - ASIMMETRICA - ASYMMETRIC	ASIM	GR			
E4112-LBC/LBN			NE			
E4113-LBC/LBN			BW			

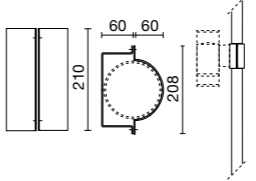
I CARATTERI ROSSI DEL CODICE INDICANO UNA VARIANTE - THE RED CHARACTERS IN A CODE INDICATE AN ALTERNATIVE

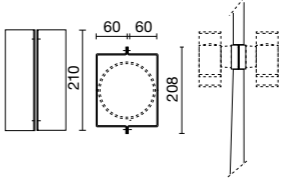
ACCESSORI - ACCESSORIES PER APPARECCHI DA ESTERNO - FOR OUTDOOR FIXTURES

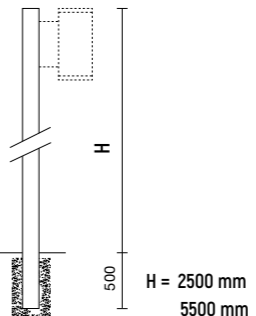

CODICE CODE	DESCRIZIONE DESCRIPTION	COLORE FINISH		
E8755	TESTA PALO SINGOLO - SINGLE POLE TOP BRACKET per apparecchio singolo - for one downlight fixture only	BR		TESTA PALO SINGOLO 
E8756		NE		
E8757		GR		
E8758	TESTA PALO DOPPIO - DOUBLE POLE BRACKET per apparecchio doppio - for two downlight fixtures	BR		TESTA PALO DOPPIO 
E8759		NE		
E8760		GR		
E5191	ATTACCO PALO SINGOLO - SINGLE POLE ADAPTER Attacco per palo - Pole bracket - ø60mm	BR		ATTACCO PALO SINGOLO 
E5192		NE		
E5193		GR		
E5195	ATTACCO PALO SINGOLO - SINGLE POLE ADAPTER Attacco per palo - Pole bracket - ø120mm	BR		ATTACCO PALO SINGOLO 
E5196		NE		
E5197		GR		
E5191-2	ATTACCO PALO DOPPIO - DOUBLE POLE ADAPTER Attacco per palo - Pole bracket - ø60mm	BR		ATTACCO PALO DOPPIO 
E5192-2		NE		
E5193-2		GR		
E5195-2	ATTACCO PALO DOPPIO - DOUBLE POLE ADAPTER Attacco per palo - Pole bracket - ø120mm	BR		
E5196-2		NE		
E5197-2		GR		
E4056-3	PALO QUADRO - SQUARE POLE H. 3000mm	NE		PALO QUADRO 
E4056-6	PALO QUADRO - SQUARE POLE H. 6000mm	NE		

105

CEILING 105
12,9W 1100Lm



CEILING 105 S
12,9W 1100Lm



140

CEILING 140
20W - 2000Lm



CEILING 140 S
20W - 2000Lm



CEILING 140 Q
41W - 4900Lm



NEW RULED LINEAR IP PLAFONE
14W - 1470Lm



175

CEILING 175
40W 4600Lm



CEILING 175 S
40W 4600Lm



250

NEW RULED LINEAR IP PLAFONE
27W - 2950Lm



360

NEW RULED LINEAR IP PLAFONE
40W - 4400Lm



PLAFONE - CEILING



CODICE CODE	DESCRIZIONE DESCRIPTION	FASCIO BEAM	COLORE FINISH		
E3800-LBC/LBN-75	RULED LINEAR IP54 PLAFONE 3 LED - L. 132mm - 14W 1470Lm 500mA IP65	75°	NE		
E3805-LBC/LBN-75	RULED LINEAR IP54 PLAFONE 6 LED - L. 247mm - 27W 2950Lm 500mA IP65	75°	NE		
E3810-LBC/LBN-75	RULED LINEAR IP54 PLAFONE 9 LED - L. 362mm - 40W 4400Lm 500mA IP65	75°	NE		

NEW RULED LINEAR IP PLAFONE



IP 65 UGR 19 a richiesta on request

PLAFONE - SOSPENSIONE - CEILING - SUSPENSION



CODICE CODE	DESCRIZIONE DESCRIPTION	FASCIO BEAM	COLORE FINISH			
E5556C-LBC/LBN-15/24/40	CEILING 105 12,9W 1100Lm 350mA IP65	15 - 24 - 40°	BR			
E5557C-LBC/LBN-15/24/40			NE			
E5558C-LBC/LBN-15/24/40			GR			
E5596-LBC/LBN-16/24/40	CEILING 140 20W 2000Lm 500mA IP65	16 - 24 - 40°	BR			
E5597-LBC/LBN-16/24/40			NE			
E5598-LBC/LBN-16/24/40			GR			
E5686-LBC/LBN-16/25/40	CEILING 175 40W 4600Lm 1050mA IP65	15 - 25 - 40°	BR			
E5687-LBC/LBN-16/25/40			NE			
E5688-LBC/LBN-16/25/40			GR			
E5556C-LBC/LBN15/24/40S	CEILING S 105 12,9W 1100Lm 350mA IP65	15 - 24 - 40°	BR			
E5557C-LBC/LBN15/24/40S			NE			
E5558C-LBC/LBN15/24/40S			GR			
E5596-LBC/LBN-16/24/40S	CEILING S 140 20W 2000Lm 500mA IP65	15 - 24 - 40°	BR			
E5597-LBC/LBN-16/24/40S			NE			
E5598-LBC/LBN-16/24/40S			GR			
E5686-LBC/LBN-16/24/40S	CEILING S 175 40W 4600Lm 1050mA IP65	15 - 25 - 40°	BR			
E5687-LBC/LBN-16/24/40S			NE			
E5688-LBC/LBN-16/24/40S			GR			
E5357-LBC/LBN-15/40/60	CEILING 140 Q 41W - 4900Lm 1050mA IP65	15 - 40 - 60°	BR			
E5358-LBC/LBN-15/40/60			NE			
E5359-LBC/LBN-15/40/60			GR			

I CARATTERI ROSSI DEL CODICE INDICANO UNA VARIANTE - THE RED CHARACTERS IN A CODE INDICATE AN ALTERNATIVE

PLAFONE-PARETE - CEILING-WALL

APPLICAZIONE DA ESTERNO RESIDENZIALE - OUTDOOR RESIDENTIAL INSTALLATION

FENIX
15W 800Lm



170

QUARTO DI SFERA
39W 1300Lm



MOON
14W 800Lm



CERKIO XS
14W 700Lm



SOLID
22,4W 880/1400Lm



MISTRAL
10/19W 650/1300Lm



250

CERKIO XL
22W 1300Lm



MISTRAL
25/48W 1300/2700Lm



350

PLAFONE-PARETE - CEILING-WALL



CODICE CODE	DESCRIZIONE DESCRIPTION	FASCIO BEAM	COLORE FINISH		
E8500-LBC/LBN	FENIX 15W 800Lm 550mA IP65	SIM	BR		
E8501-LBC/LBN	FENIX 15W 800Lm 550mA IP65	SIM	NE		
E8540-LBC/LBN/LBI	QUARTO DI SFERA 39W 1300Lm 700mA IP65	-	BR		
E8540-LBC/LBN/LBI			NE		
E8540-LBC/LBN/LBI			GR		
E8540-LBC/LBN/LBI-EM	QUARTO DI SFERA 20W 700Lm 350mA IP65 - EMERGENZA - EMERGENCY - 1H	-	BR		
E8540-LBC/LBN/LBI-EM			NE		
E8540-LBC/LBN/LBI-EM			GR		
E5420-LBC/LBN/LBI	MOON 14W 800Lm 350mA IP65 IK10	-	BR		
E5421-LBC/LBN/LBI			NE		
E5422-LBC/LBN/LBI			GR		
E5420-LBC/LBN-EM	MOON 10,6W 600Lm 350mA IP65 IK10 - EMERGENZA - EMERGENCY - 1H	-	BR		
E5421-LBC/LBN-EM			NE		
E5422-LBC/LBN-EM			GR		
E5430-LBC/LBN/LBI	MOON 14W 450Lm 350mA IP65 IK10 - con palpebra/with eyelid	-	BR		
E5431-LBC/LBN/LBI			NE		
E5422-LBC/LBN/LBI			GR		
E5430-LBC/LBN-EM	MOON 10,6W 400Lm 350mA IP65 IK10 - EMERGENZA - EMERGENCY - 1H - con palpebra/with eyelid	-	BR		
E5431-LBC/LBN-EM			NE		
E5432-LBC/LBN-EM			GR		
E5446-LBC/LBN/LBI	CERKIO XS 14W 700Lm 350mA IP65 IK10	120°	BR		
E5447-LBC/LBN/LBI			NE		
E5448-LBC/LBN/LBI			GR		
E5446-LBC/LBN/LBI-EM	CERKIO XS 14W 600Lm 350mA IP65 IK10 - EMERGENZA - EMERGENCY - 1H	120°	BR		
E5447-LBC/LBN/LBI-EM			NE		
E5448-LBC/LBN/LBI-EM			GR		
E5400-LBC/LBN/LBI	CERKIO XL 22W 1300Lm 700mA IP65 IK10	120°	BR		
E5401-LBC/LBN/LBI			NE		
E5402-LBC/LBN/LBI			GR		

FENIX



QUARTO DI SFERA



MOON



CERKIO XS



CERKIO XL

IK08 IP65 DALI EM a richiesta - on request

PLAFONE-PARETE - CEILING-WALL



CODICE CODE	DESCRIZIONE DESCRIPTION	FASCIO BEAM	COLORE FINISH		
E5385-LBC/LBN	SOLID 22,4W 1400Lm 700mA IP65 IK10 - TUTTO SCHERMO - FULL SCREEN	110°	BR		
E5386-LBC/LBN			NE		
E5387-LBC/LBN			GR		
E5393-LBC/LBN	SOLID 22,4W 1400Lm 700mA IP65 IK10 - TUTTO SCHERMO - FULL SCREEN - doppia accensione/double switch	110°	BR		
E5394-LBC/LBN			NE		
E5395-LBC/LBN			GR		
E5385-LBC/LBN-EM	SOLID 22,4W 1400Lm 700mA IP65 IK10 - TUTTO SCHERMO - FULL SCREEN - EMERGENZA - EMERGENCY - 1H	110°	BR		
E5386-LBC/LBN-EM			NE		
E5387-LBC/LBN-EM			GR		
E5390-LBC/LBN	SOLID 22,4W 850Lm 700mA IP65 IK10 - con palpebra/with eyelid	110°	BR		
E5391-LBC/LBN			NE		
E5392-LBC/LBN			GR		
E5396-LBC/LBN	SOLID 22,4W 850Lm 700mA IP65 IK10 - con palpebra/with eyelid - doppia accensione/double switch	110°	BR		
E5397-LBC/LBN			NE		
E5398-LBC/LBN			GR		
E5390-LBC/LBN-EM	SOLID 22,4W 850Lm 700mA IP65 IK10 - con palpebra/with eyelid - EMERGENZA - EMERGENCY - 1H	110°	BR		
E5391-LBC/LBN-EM			NE		
E5392-LBC/LBN-EM			GR		
E8805-LBC/LBN	MINI MISTRAL 10W 650Lm 400mA IP65 - MONOEMISSIONE - SINGLE SIDE EMISSION	-	BR		
E8806-LBC/LBN			NE		
E8807-LBC/LBN			GR		
E8800-LBC/LBN	MINI MISTRAL 19W 1300Lm 400mA IP65 - BIEMISSIONE - DOUBLE SIDE EMISSION	-	BR		
E8801-LBC/LBN			NE		
E8802-LBC/LBN			GR		
E8650-LBC/LBN	MISTRAL 25W 1300Lm 500mA IP65 - MONOEMISSIONE - SINGLE SIDE EMISSION	-	BR		
E8651-LBC/LBN			NE		
E8652-LBC/LBN			GR		
E8600-LBC/LBN	MISTRAL 48W 2700Lm 500mA IP65 - BIEMISSIONE - DOUBLE SIDE EMISSION	-	BR		
E8601-LBC/LBN			NE		
E8602-LBC/LBN			GR		

I CARATTERI ROSSI DEL CODICE INDICANO UNA VARIANTE - THE RED CHARACTERS IN A CODE INDICATE AN ALTERNATIVE

BOLLARDS

APPLICAZIONE DA ESTERNO URBANO RESIDENZIALE - URBAN AND RESIDENTIAL INSTALLATION

LITTLE ROK
H. 171mm
30,8W - 370/750Lm
☉ ☉

ROK
H. 232mm
30,8W - 370/660Lm
☉ ☉ ☉

Q8
H. 400 - 700mm
14,4W - 1280Lm
sidesign

VERSO 90
H. 600 - 900mm
11W - 800/1100Lm
☉ ☉

VERSO 175
H. 235 - 400 - 700 - 1000mm
20W - 1400/2000Lm
☉ ☉

VERSO 120-Q
H. 235 - 400 - 700 - 1000mm
6/11/22W - 450/900/1800Lm
☉ ☉ ☉

SPOT 50-TRIS
H. 1600mm
3x8W - 3x750Lm

ELLE XS
H. 500 - 900mm
14W - 1900Lm

ELLE XL
H. 2500mm
64W - 7500Lm

SOLARIS RESIDENZIALE
H. 3000/4500mm
40W - 3650Lm

FRISBEE
H. 600 - 900mm
16W - 850Lm

FRISBEE MAXI
91W 9000Lm

BOLLARDS



CODICE CODE	DESCRIZIONE DESCRIPTION	FASCIO BEAM	COLORE FINISH		
E8468-LBC/LBN/LBI	LITTLE ROK 30,8W 370Lm 600mA IP 67 - MONODIREZIONALE - SINGLE SIDE LIGHT	MONO	NE		
E8469-LBC/LBN/LBI			GR		
E8470-LBC/LBN/LBI	LITTLE ROK 30,8W 750Lm 600mA IP 67 - OMNIDIREZIONALE - RADIAL LIGHT	OMNI	NE		
E8471-LBC/LBN/LBI			GR		
898	ACCESSORI - ACCESSORIES Cassaforma per fissaggio interrato - Inground recessed box	-	-		
E8404-LBC/LBN/LBI	ROK 30,8W 350Lm 600mA IP67 - MONODIREZIONALE - SINGLE SIDE LIGHT	MONO	NE		
E8405-LBC/LBN/LBI			GR		
E8406-LBC/LBN/LBI	ROK 30,8W 350Lm 600mA IP67 - BIDIREZIONALE - DOUBLE SIDE LIGHT	BI	NE		
E8407-LBC/LBN/LBI			GR		
E8408-LBC/LBN/LBI	ROK 30,8W 350Lm 600mA IP67 - OMNIDIREZIONALE - RADIAL LIGHT	OMNI	NE		
E8409-LBC/LBN/LBI			GR		
646308	ACCESSORI - ACCESSORIES Connettore - Connector IP68 ø da 7 a 12mm	-	-		
898	Cassaforma per fissaggio interrato - Pit for buried installation	-	-		
880	Cassaforma + piastra per torretta - Housing + Plate for turret	-	-		
888	Torretta per fissaggio a pavimento - Turret for floor installation	-	NE		
889	Torretta per fissaggio a pavimento - Turret for floor installation	-	GR		
D2040	Q8 14,4W 1280Lm 500mA IP55- H.400mm	35°	BW		
D2041	Q8 14,4W 1280Lm 500mA IP55 - H.900mm	35°	BW		
D2040-P	Q8 14,4W 1280Lm 500mA IP55 - H.400mm - CON BASETTA - WITH BASE	35°	BW		
D2041-P	Q8 14,4W 1280Lm 500mA IP55 - H.900mm - CON BASETTA - WITH BASE	35°	BW		

LITTLE ROK

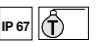

ROK

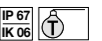

sidesign Q8

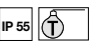

BOLLARDS



CODICE CODE	DESCRIZIONE DESCRIPTION	FASCIO BEAM	COLORE FINISH	
E5906-LBC/LBN	VERSO 90 11W 800Lm 500mA IP65 - H.600mm - MONODIREZIONALE - BEAM 180°	MONO	NE	
E5907-LBC/LBN			GRA	
E5908-LBC/LBN			BW	
E5916-LBC/LBN	VERSO 90 11W 800Lm 500mA IP65 - H.900mm - MONODIREZIONALE - BEAM 180°	MONO	NE	
E5917-LBC/LBN			GRA	
E5918-LBC/LBN			BW	
E5901-LBC/LBN	VERSO 90 11W 1100Lm 500mA IP65 - H.600mm - OMNIDIREZIONALE - BEAM 360°	OMNI	NE	
E5902-LBC/LBN			GRA	
E5903-LBC/LBN			BW	
E5911-LBC/LBN	VERSO 90 11W 1100Lm 500mA IP65 - H.900mm - OMNIDIREZIONALE - BEAM 360°	OMNI	NE	
E5912-LBC/LBN			GRA	
E5913-LBC/LBN			BW	
3127	ACCESSORI - ACCESSORIES Anello in acciaio inox AISI 316 L per copertura base ø 160 mm Base cover Ø160mm. - stainless steel AISI 316L	-	-	
894	Cassaforma per fissaggio a terra - Inground recessed box	-	-	
646308	Connettore - Connector IP68 ø da 7 a 10mm	-	-	
646636	Connettore - Connector IP68 a "T" ø da 7 a 10mm per file continue - for continuous lines	-	-	
4073	Piastra tirafondi in acciaio zincato - Galvanized steel fixing plate	-	-	

VERSO 90

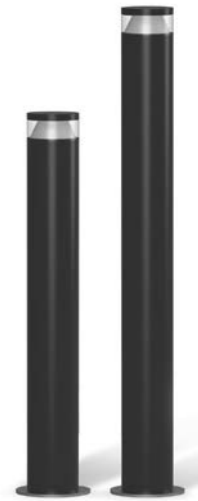

H = 600 mm
900 mm

3127

894

646308
646636

4073



BOLLARDS



CODICE CODE	DESCRIZIONE DESCRIPTION	FASCIO BEAM	COLORE FINISH
E5961-LBC/LBN	VERSO 175 20W 1400Lm 500mA IP65 - H.235mm - MONODIREZIONALE - BEAM 180°	MONO	NE
E5962-LBC/LBN			GRA
E5963-LBC/LBN			BW
E5941-LBC/LBN	VERSO 175 20W 1400Lm 500mA IP65 - H.400mm - MONODIREZIONALE - BEAM 180°	MONO	NE
E5942-LBC/LBN			GRA
E5943-LBC/LBN			BW
E5946-LBC/LBN	VERSO 175 20W 1400Lm 500mA IP65 - H.700mm - MONODIREZIONALE - BEAM 180°	MONO	NE
E5947-LBC/LBN			GRA
E5948-LBC/LBN			BW
E5951-LBC/LBN	VERSO 175 20W 1400Lm 500mA IP65 - H.1000mm - MONODIREZIONALE - BEAM 180°	MONO	NE
E5952-LBC/LBN			GRA
E5953-LBC/LBN			BW
E5956-LBC/LBN	VERSO 175 20W 2000Lm 500mA IP65 - H.235mm - OMNIDIREZIONALE - BEAM 360°	OMNI	NE
E5957-LBC/LBN			GRA
E5958-LBC/LBN			BW
E5921-LBC/LBN	VERSO 175 20W 2000Lm 500mA IP65 - H.400mm - OMNIDIREZIONALE - BEAM 360°	OMNI	NE
E5922-LBC/LBN			GRA
E5923-LBC/LBN			BW
E5926-LBC/LBN	VERSO 175 20W 2000Lm 500mA IP65 - H.700mm - OMNIDIREZIONALE - BEAM 360°	OMNI	NE
E5927-LBC/LBN			GRA
E5928-LBC/LBN			BW
E5931-LBC/LBN	VERSO 175 20W 2000Lm 500mA IP65 - H.1000mm - OMNIDIREZIONALE - BEAM 360°	OMNI	NE
E5932-LBC/LBN			GRA
E5933-LBC/LBN			BW
899	ACCESSORI - ACCESSORIES Cassaforma per fissaggio a terra - Inground recessed box	-	-
646308	Connettore - Connector IP68 ø da 7 a 10mm	-	-
646636	Connettore - Connector IP68 a "T" ø da 7 a 10mm per file continue - for continuous lines	-	-
4074	Piastra tirafondi in acciaio zincato - Galvanized steel fixing plate	-	-

VERSO 175

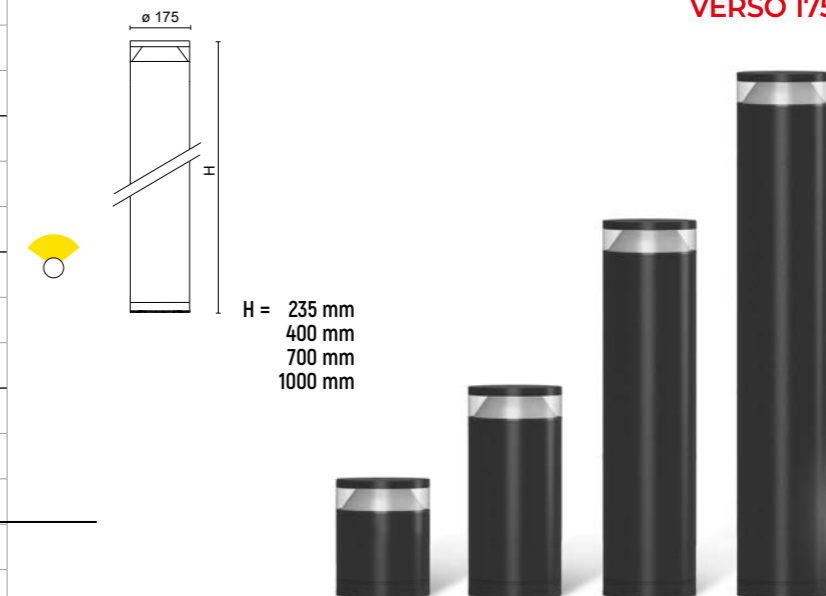

H = 235 mm
400 mm
700 mm
1000 mm

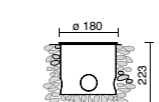
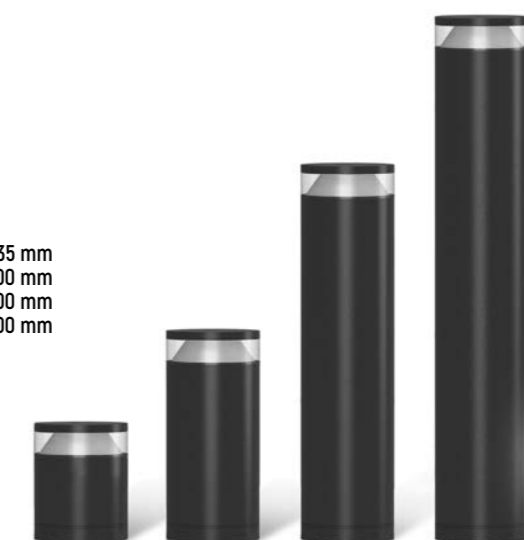

899 Cassaforma

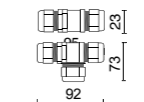

646308 Connettore
646636

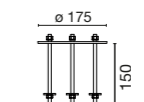

4074 Piastra tirafondi



BOLLARDS



CODICE CODE	DESCRIZIONE DESCRIPTION	FASCIO BEAM	COLORE FINISH
E5961-LBC/LBN-N	VERSO 175 EVO 20W 1400Lm 500mA IP65 - H.235mm - MONODIREZIONALE - BEAM 180°	MONO	NE
E5962-LBC/LBN-N			GRA
E5963-LBC/LBN-N			BW
E5941-LBC/LBN-N	VERSO 175 EVO 20W 1400Lm 500mA IP65 - H.400mm - MONODIREZIONALE - BEAM 180°	MONO	NE
E5942-LBC/LBN-N			GRA
E5943-LBC/LBN-N			BW
E5946-LBC/LBN-N	VERSO 175 EVO 20W 1400Lm 500mA IP65 - H.700mm - MONODIREZIONALE - BEAM 180°	MONO	NE
E5947-LBC/LBN-N			GRA
E5948-LBC/LBN-N			BW
E5951-LBC/LBN-N	VERSO 175 EVO 20W 1400Lm 500mA IP65 - H.1000mm - MONODIREZIONALE - BEAM 180°	MONO	NE
E5952-LBC/LBN-N			GRA
E5953-LBC/LBN-N			BW
E5956-LBC/LBN-N	VERSO 175 EVO 20W 2000Lm 500mA IP65 - H.235mm - OMNIDIREZIONALE - BEAM 360°	OMNI	NE
E5957-LBC/LBN-N			GRA
E5958-LBC/LBN-N			BW
E5921-LBC/LBN-N	VERSO 175 EVO 20W 2000Lm 500mA IP65 - H.400mm - OMNIDIREZIONALE - BEAM 360°	OMNI	NE
E5922-LBC/LBN-N			GRA
E5923-LBC/LBN-N			BW
E5926-LBC/LBN-N	VERSO 175 EVO 20W 2000Lm 500mA IP65 - H.700mm - OMNIDIREZIONALE - BEAM 360°	OMNI	NE
E5927-LBC/LBN-N			GRA
E5928-LBC/LBN-N			BW
E5931-LBC/LBN-N	VERSO 175 EVO 20W 2000Lm 500mA IP65 - H.1000mm - OMNIDIREZIONALE - BEAM 360°	OMNI	NE
E5932-LBC/LBN-N			GRA
E5933-LBC/LBN-N			BW
899-N	ACCESSORI - ACCESSORIES Cassaforma per fissaggio a terra - Inground recessed box	-	-
646308	Connettore - Connector IP68 ø da 7 a 10mm	-	-
646636	Connettore - Connector IP68 a "T" ø da 7 a 10mm per file continue - for continuous lines	-	-
4074-N	Piastra tirafondi in acciaio zincato - Galvanized steel fixing plate	-	-

NEW **VERSO 175 EVO**

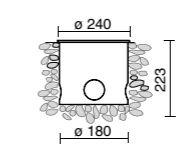
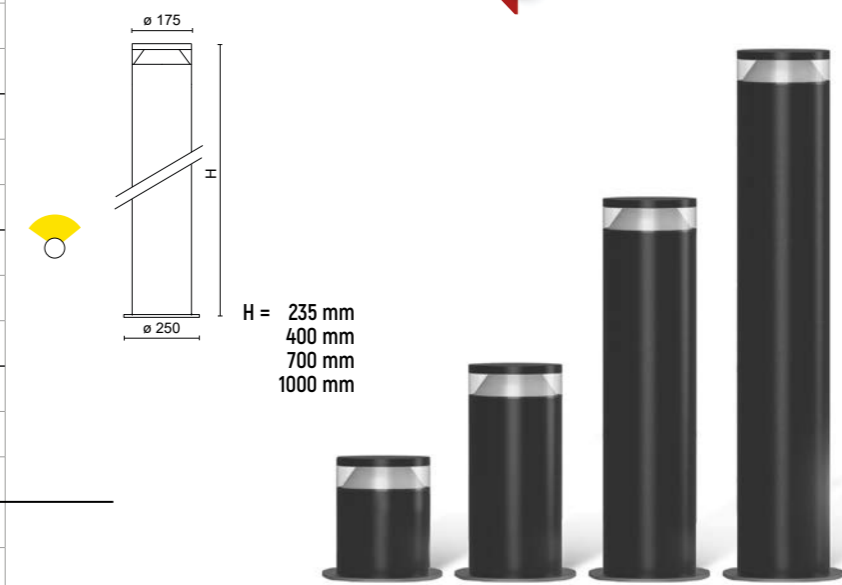

899-N Cassaforma

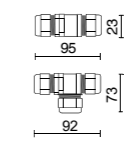

646308 Connettore

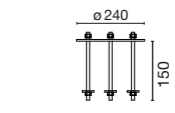

4074-N Piastra tirafondi



a richiesta on request **DALLI**

BOLLARDS



CODICE CODE	DESCRIZIONE DESCRIPTION	FASCIO BEAM	COLORE FINISH
E6040-LBC/LBN	VERSO 175 KONIC 23W 430Lm 500mA IP65 - H.235mm - MONODIREZIONALE - BEAM 180°	MONO	NE
E6041-LBC/LBN			GRA
E6042-LBC/LBN			BW
E6045-LBC/LBN	VERSO 175 KONIC 23W 430Lm 500mA IP65 - H.400mm - MONODIREZIONALE - BEAM 180°	MONO	NE
E6046-LBC/LBN			GRA
E6047-LBC/LBN			BW
E6050-LBC/LBN	VERSO 175 KONIC 23W 430Lm 500mA IP65 - H.700mm - MONODIREZIONALE - BEAM 180°	MONO	NE
E6051-LBC/LBN			GRA
E6052-LBC/LBN			BW
E6055-LBC/LBN	VERSO 175 KONIC 23W 430Lm 500mA IP65 - H.1000mm - MONODIREZIONALE - BEAM 180°	MONO	NE
E6056-LBC/LBN			GRA
E6057-LBC/LBN			BW
E6020-LBC/LBN	VERSO 175 KONIC 23W 860Lm 500mA IP65 - H.235mm - OMNIDIREZIONALE - BEAM 360°	OMNI	NE
E6021-LBC/LBN			GRA
E6022-LBC/LBN			BW
E6025-LBC/LBN	VERSO 175 KONIC 23W 860Lm 500mA IP65 - H.400mm - OMNIDIREZIONALE - BEAM 360°	OMNI	NE
E6026-LBC/LBN			GRA
E6027-LBC/LBN			BW
E6030-LBC/LBN	VERSO 175 KONIC 23W 860Lm 500mA IP65 - H.700mm - OMNIDIREZIONALE - BEAM 360°	OMNI	NE
E6031-LBC/LBN			GRA
E6032-LBC/LBN			BW
E6035-LBC/LBN	VERSO 175 KONIC 23W 860Lm 500mA IP65 - H.1000mm - OMNIDIREZIONALE - BEAM 360°	OMNI	NE
E6036-LBC/LBN			GRA
E6037-LBC/LBN			BW
899	ACCESSORI - ACCESSORIES Cassaforma per fissaggio a terra - Inground recessed box	-	-
646308	Connettore - Connector IP68 ø da 7 a 10mm	-	-
646636	Connettore - Connector IP68 a "T" ø da 7 a 10mm per file continue - for continuous lines	-	-
4074	Piastra tirafondi in acciaio zincato - Galvanized steel fixing plate	-	-

NEW VERSO KONIC 175

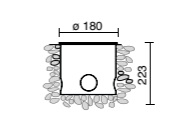
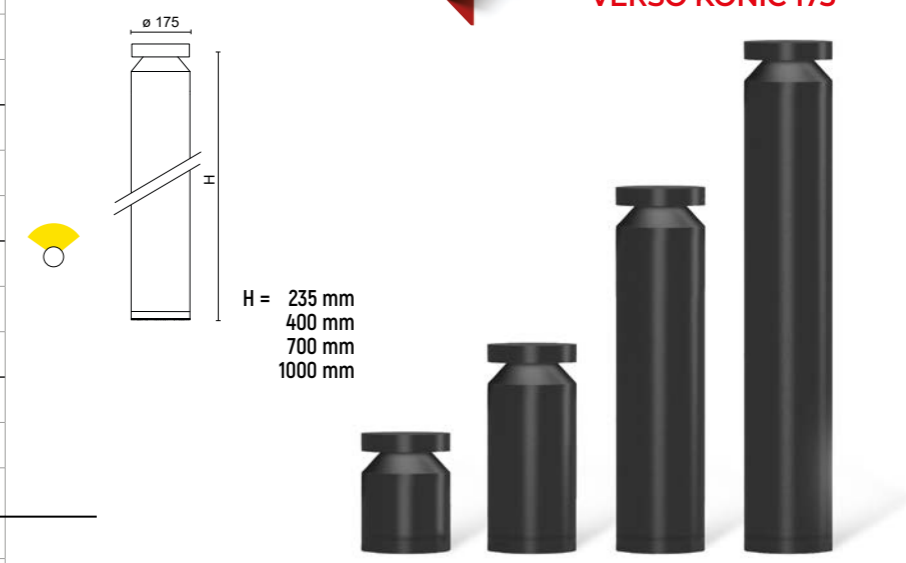

899 Cassaforma

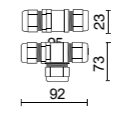

646308 Connettore
646636

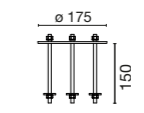

4074 Piastra tirafondi



BOLLARDS



CODICE CODE	DESCRIZIONE DESCRIPTION	FASCIO BEAM	COLORE FINISH
E6040-LBC/LBN-N	VERSO 175 KONIC EVO 23W 430Lm 500mA IP65 - H.235mm - MONODIREZIONALE - BEAM 180°	MONO	NE
E6041-LBC/LBN-N			GRA
E6042-LBC/LBN-N			BW
E6045-LBC/LBN-N	VERSO 175 KONIC EVO 23W 430Lm 500mA IP65 - H.400mm - MONODIREZIONALE - BEAM 180°	MONO	NE
E6046-LBC/LBN-N			GRA
E6047-LBC/LBN-N			BW
E6050-LBC/LBN-N	VERSO 175 KONIC EVO 23W 430Lm 500mA IP65 - H.700mm - MONODIREZIONALE - BEAM 180°	MONO	NE
E6051-LBC/LBN-N			GRA
E6052-LBC/LBN-N			BW
E6055-LBC/LBN-N	VERSO 175 KONIC EVO 23W 430Lm 500mA IP65 - H.1000mm - MONODIREZIONALE - BEAM 180°	MONO	NE
E6056-LBC/LBN-N			GRA
E6057-LBC/LBN-N			BW
E6020-LBC/LBN-N	VERSO 175 KONIC EVO 23W 860Lm 500mA IP65 - H.235mm - OMNIDIREZIONALE - BEAM 360°	OMNI	NE
E6021-LBC/LBN-N			GRA
E6022-LBC/LBN-N			BW
E6025-LBC/LBN-N	VERSO 175 KONIC EVO 23W 860Lm 500mA IP65 - H.400mm - OMNIDIREZIONALE - BEAM 360°	OMNI	NE
E6026-LBC/LBN-N			GRA
E6027-LBC/LBN-N			BW
E6030-LBC/LBN-N	VERSO 175 KONIC EVO 23W 860Lm 500mA IP65 - H.700mm - OMNIDIREZIONALE - BEAM 360°	OMNI	NE
E6031-LBC/LBN-N			GRA
E6032-LBC/LBN-N			BW
E6035-LBC/LBN-N	VERSO 175 KONIC EVO 23W 860Lm 500mA IP65 - H.1000mm - OMNIDIREZIONALE - BEAM 360°	OMNI	NE
E6036-LBC/LBN-N			GRA
E6037-LBC/LBN-N			BW
899-N	ACCESSORI - ACCESSORIES Cassaforma per fissaggio a terra - Inground recessed box	-	-
646308	Connettore - Connector IP68 ø da 7 a 10mm	-	-
646636	Connettore - Connector IP68 a "T" ø da 7 a 10mm per file continue - for continuous lines	-	-
4074-N	Piastra tirafondi in acciaio zincato - Galvanized steel fixing plate	-	-

NEW **VERSO 175 KONIC EVO**

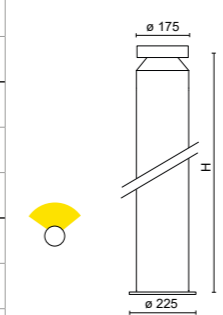

H = 235 mm
400 mm
700 mm
1000 mm

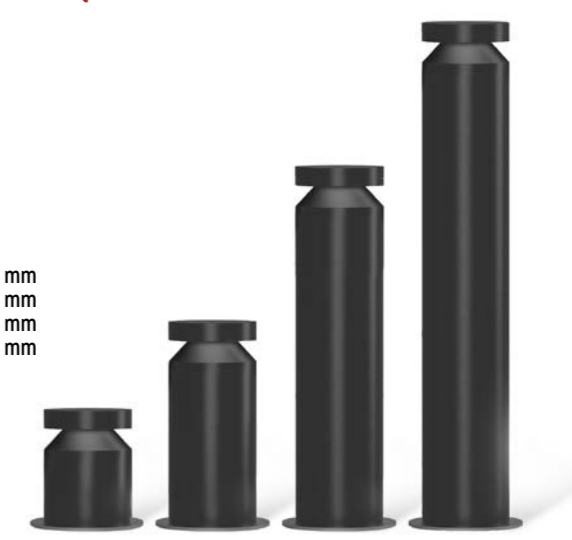

SENSORE INFRAROSSO A RICHIESTA
ON REQUEST P.I.R. SENSOR

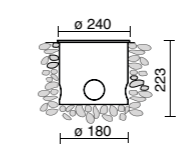

899-N Cassaforma

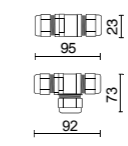

646308 Connettore

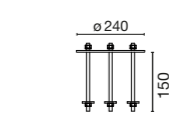

4074-N Piastra tirafondi



BOLLARDS



CODICE CODE	DESCRIZIONE DESCRIPTION	FASCIO BEAM	COLORE FINISH
E6150-LBC/LBN	VERSO 120-Q 6W 450Lm 24Vdc IP65 - H.235mm - MONODIREZIONALE - BEAM 90°	MONO	NE
E6151-LBC/LBN			GRA
E6152-LBC/LBN			BW
E6155-LBC/LBN	VERSO 120-Q 6W 450Lm 24Vdc IP65 - H.400mm - MONODIREZIONALE - BEAM 90°	MONO	NE
E6156-LBC/LBN			GRA
E6157-LBC/LBN			BW
E6160-LBC/LBN	VERSO 120-Q 6W 450Lm 24Vdc IP65 - H.700mm - MONODIREZIONALE - BEAM 90°	MONO	NE
E6161-LBC/LBN			GRA
E6162-LBC/LBN			BW
E6165-LBC/LBN	VERSO 120-Q 6W 450Lm 24Vdc IP65 - H.1000mm - MONODIREZIONALE - BEAM 90°	MONO	NE
E6166-LBC/LBN			GRA
E6167-LBC/LBN			BW
E6125-LBC/LBN	VERSO 120-Q 10W 900Lm 24Vdc IP65 - H.235mm - BIDIREZIONALE - BEAM 90 + 90°	BI	NE
E6126-LBC/LBN			GRA
E6127-LBC/LBN			BW
E6130-LBC/LBN	VERSO 120-Q 10W 900Lm 24Vdc IP65 - H.400mm - BIDIREZIONALE - BEAM 90 + 90°	BI	NE
E6131-LBC/LBN			GRA
E6132-LBC/LBN			BW
E6135-LBC/LBN	VERSO 120-Q 10W 900Lm 24Vdc IP65 - H.700mm - BIDIREZIONALE - BEAM 90 + 90°	BI	NE
E6136-LBC/LBN			GRA
E6137-LBC/LBN			BW
E6140-LBC/LBN	VERSO 120-Q 10W 900Lm 24Vdc IP65 - H.1000mm - BIDIREZIONALE - BEAM 90 + 90°	BI	NE
E6141-LBC/LBN			GRA
E6142-LBC/LBN			BW
E6100-LBC/LBN	VERSO 120-Q 22W 1800Lm 24Vdc IP65 - H.235mm - OMNIDIREZIONALE - BEAM 360°	OMNI	NE
E6101-LBC/LBN			GRA
E6102-LBC/LBN			BW
E6105-LBC/LBN	VERSO 120-Q 22W 1800Lm 24Vdc IP65 - H.400mm - OMNIDIREZIONALE - BEAM 360°	OMNI	NE
E6106-LBC/LBN			GRA
E6107-LBC/LBN			BW
E6110-LBC/LBN	VERSO 120-Q 22W 1800Lm 24Vdc IP65 - H.700mm - OMNIDIREZIONALE - BEAM 360°	OMNI	NE
E6111-LBC/LBN			GRA
E6112-LBC/LBN			BW
E6115-LBC/LBN	VERSO 120-Q 22W 1800Lm 24Vdc IP65 - H.1000mm - OMNIDIREZIONALE - BEAM 360°	OMNI	NE
E6116-LBC/LBN			GRA
E6117-LBC/LBN			BW
646308	ACCESSORI - ACCESSORIES Connettore - Connector IP68 ø da 7 a 10mm	-	-
646636	Connettore - Connector IP68 a "T" ø da 7 a 10mm per file continue - for continuous lines	-	-
896	Cassaforma per fissaggio a terra - Inground recessed box	-	-

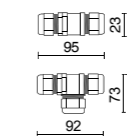
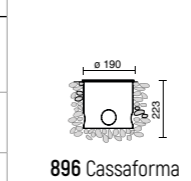
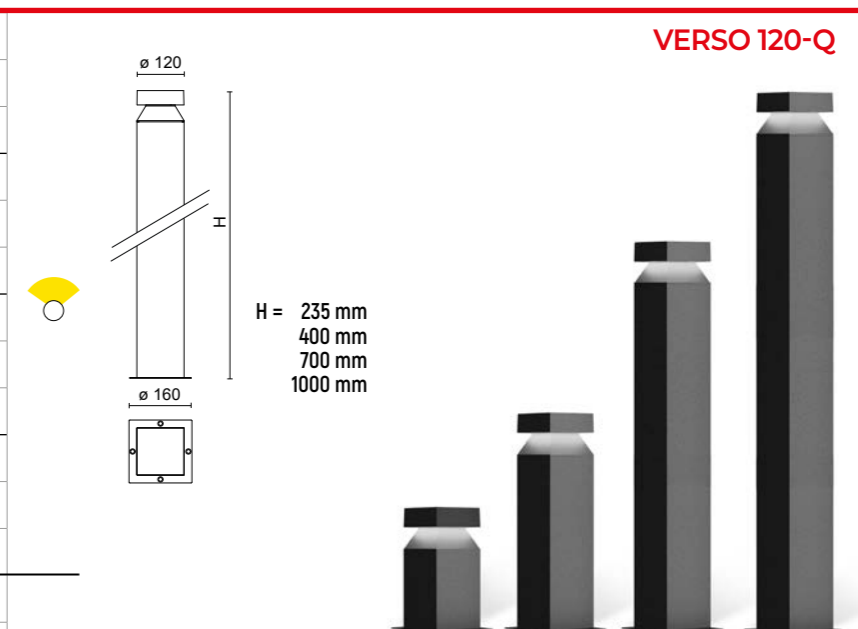

896 Cassaforma 646308 Connettore
646636

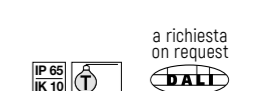

BOLLARDS



NEW SPOT 50-TRIS

CODICE CODE	DESCRIZIONE DESCRIPTION	FASCIO BEAM	COLORE FINISH
E67920-LBC/LBN-S	SPOT 50-TRIS 3x8W 3x760Lm 200mA IP67 IK07	12°	GR
E67921-LBC/LBN-S	SPOT 50-TRIS 3x8W 3x760Lm 200mA IP67 IK07	12°	NE
E67922-LBC/LBN-S	SPOT 50-TRIS 3x8W 3x760Lm 200mA IP67 IK07	12°	BW
E67923-LBC/LBN-S	SPOT 50-TRIS 3x8W 3x760Lm 200mA IP67 IK07	12°	VE
E67924-LBC/LBN-S	SPOT 50-TRIS 3x8W 3x760Lm 200mA IP67 IK07	12°	CORTEN
E67925-LBL	ACCESSORI - ACCESSORIES EYES LED TESTA PALO - LIGHT POLE-TOP 3.5W 350mA 230V - BLU - BLUE	-	-
E67925-LVE	EYES LED TESTA PALO - LIGHT POLE-TOP 3.5W 350mA 230V - VERDE - GREEN	-	-
E67925-LRO	EYES LED TESTA PALO - LIGHT POLE-TOP 3.5W 350mA 230V - ROSSO - RED	-	-
894	POZZETTO PER FISSAGGIO A TERRA - PIT FOR GROUND FIXING	-	-
3159	SCATOLA DERIVAZIONE 5 VIE - 5 WAYS JUNCTION BOX - IP68	-	-
3147-GR/NE/BW/VE/CO	Cilindro di schermatura - Shielding cylinder	-	GR - NE - BW - VE - CO
3148-GR/NE/BW/VE/CO	Cilindro di schermatura - Shielding cylinder 45°	-	GR - NE - BW - VE - CO
3149-GR/NE/BW/VE/CO	Cornice per accessori - Frame holder for accessory	-	GR - NE - BW - VE - CO
3146	Griglia alveolare - Alveolar grid	-	-
3145	Lente ellittica - Elliptical lens	-	-
3144	Lente diffondente - Wide flood	-	-

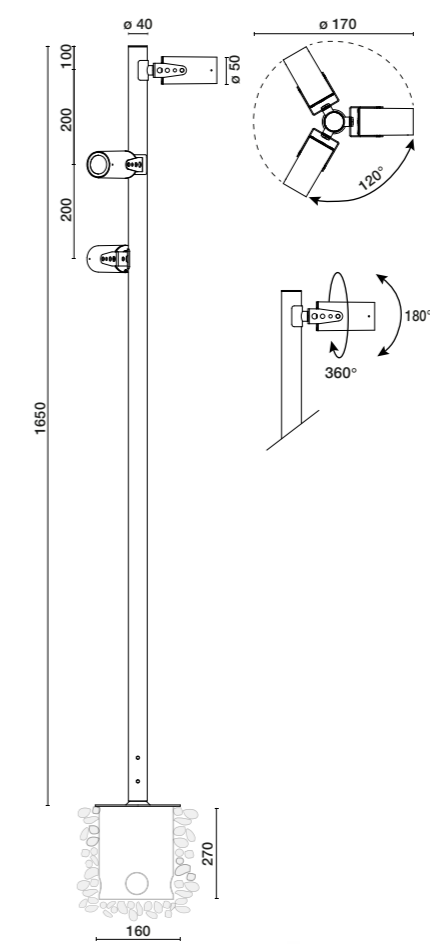

N.B. I cavi devono essere collegati ad una muffola stagna IP68
The cables must be connected to an IP68 waterproof connector

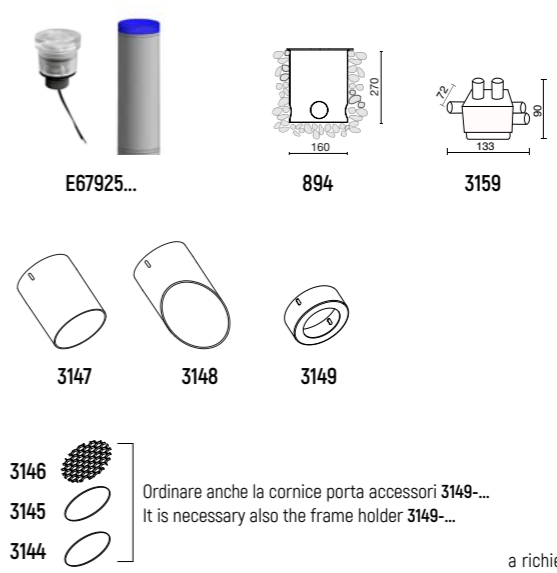

3146
3145
3144
Ordinare anche la cornice porta accessori 3149-...
It is necessary also the frame holder 3149-...

a richiesta - on request
fascio/beam 18° - 34°
IP 67 IK 07

BOLLARDS



CODICE CODE	DESCRIZIONE DESCRIPTION	FASCIO BEAM	COLORE FINISH
E5676-LBC/LBN	FRISBEE 16W 850Lm 500mA IP65 - Vano ottico - Optical compartment	OMNI	BR
E5677-LBC/LBN			NE
E5678-LBC/LBN			GR
E5679-LBC/LBN			BW
E5652	FRISBEE Palo a pavimento - Pole with fixing plate - H.600mm	OMNI	BR
E5653			NE
E5654			GR
E5655			BW
E5656	FRISBEE Palo a pavimento - Pole with fixing plate - H.900mm	OMNI	BR
E5657			NE
E5658			GR
E5659			BW
874	FRISBEE Copribase inox - Stainless steel base cover	OMNI	INOX
894	ACCESSORI - ACCESSORIES Cassaforma per fissaggio a terra - Inground recessed box	-	-
646308	Connettore - Connector IP68 ø da 7 a 10mm	-	-
406407	Adattatore per palo - Adaptator for pole - ø 76/60	-	NE
406419	Adattatore per palo - Adaptator for pole - ø 76/60	-	GR
406408	Adattatore per palo - Adaptator for pole - ø 76/60	-	BW
E5690-LBC/LBN	FRISBEE MAXI 91W 9000Lm 400mA IP65 - Vano ottico - Optical compartment	OMNI	NE
E5691-LBC/LBN			GRA
E5692-LBC/LBN			GR
E5693-LBC/LBN			BW
406207/59/19/08	ACCESSORI - ACCESSORIES Palo da interrare acciaio zincato verniciato - Floor pole - Ø 60 mm. - H 3 m.	-	NE - GRA - GR - BW
408107/59/19/08	Palo da interrare acciaio zincato verniciato - Floor pole - Ø 60 mm. - H 4 m. NEW	-	NE - GRA - GR - BW
408207/59/19/08	Palo da interrare acciaio zincato verniciato - Floor pole - Ø 60 mm. - H 4 m. NEW	-	NE - GRA - GR - BW
406307	Base palo da pavimento - Base for floor pole - ø 60 mm.	-	NE
406359			GRA
406319			GR
406308			BW
406407	Riduzione attacco palo acciaio zincato verniciato - ø 76/60 mm.	-	NE
406459			GRA
406419			GR
406408			BW
895	Cassaforma per fissaggio interrato - Inground recessed box	-	-
4071	Piastra tirafondi in acciaio zincato - Galvanized steel fixing plate	-	-

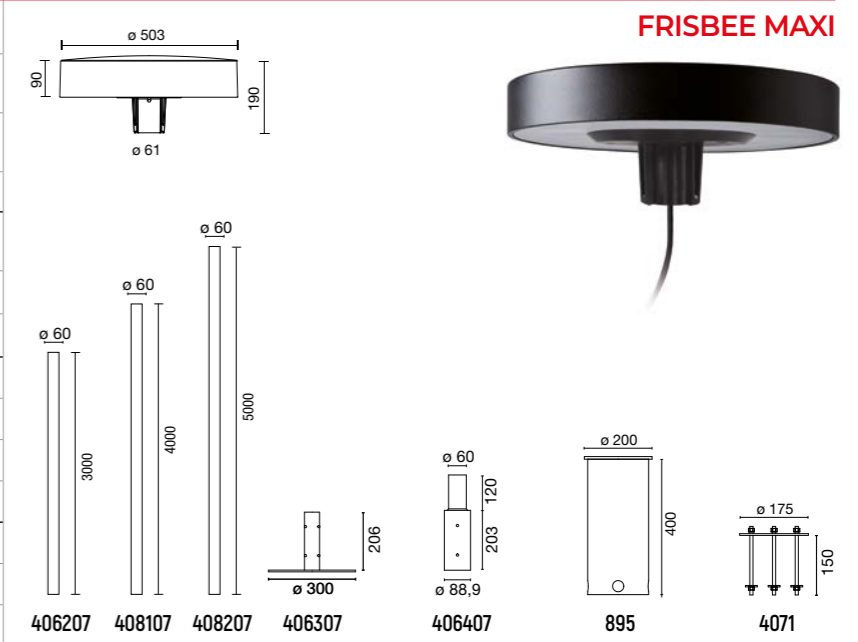
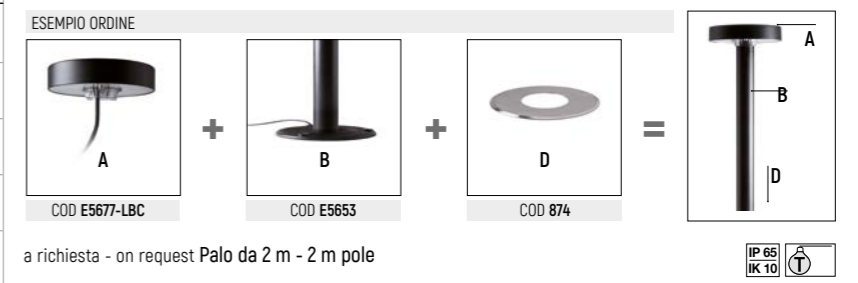
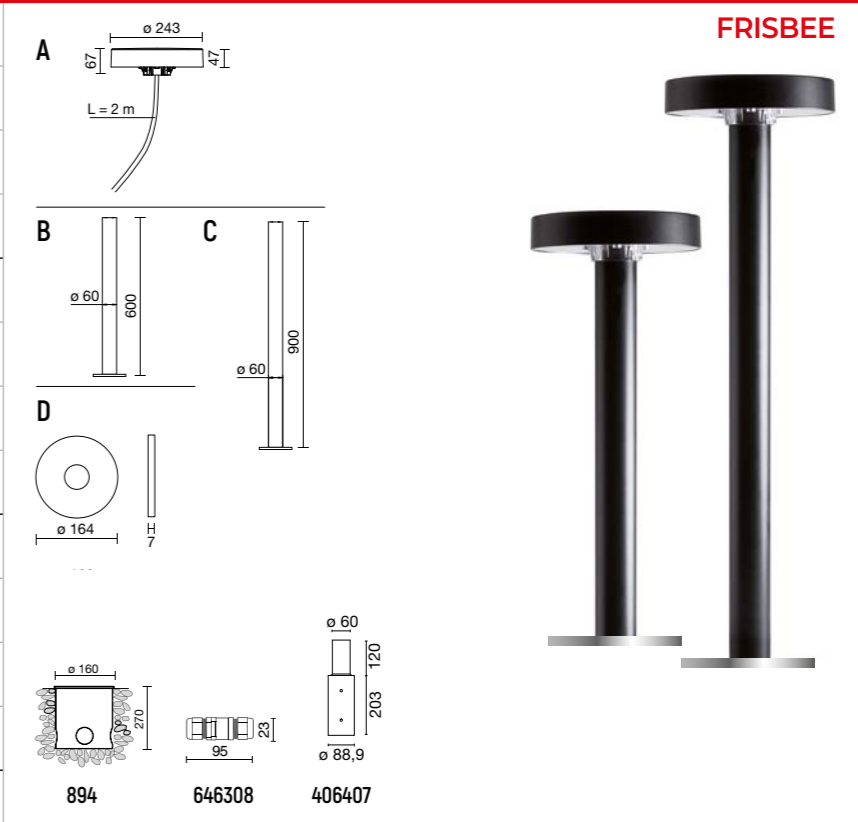

a richiesta - on request
Palo da 5 m - 5 m pole
Potenza da 40W a 90W - Power from 40W to 90W
IP 65 IK 10

PARETE - TERRA - OUTDOOR WALL GROUND LIGHTS



CODICE CODE	DESCRIZIONE DESCRIPTION	FASCIO BEAM	COLORE FINISH		
E4071-LBC/LBN	ELLE XS 14W 1900Lm - H.500mm - SIMMETRICA/SYMMETRIC - Basetta a pavimento/Base for floorings	SIM	GR	<p>CON BASETTA A PAVIMENTO WITH BASEPLATE FOR CONCRETE H = 500 mm 900 mm</p>	
E4072-LBC/LBN			NE		
E4073-LBC/LBN			BW		
E4074-LBC/LBN	ELLE XS 14W 1900Lm - H.900mm - SIMMETRICA/SYMMETRIC - Basetta a pavimento/Base for floorings	SIM	GR		
E4075-LBC/LBN			NE		
E4076-LBC/LBN			BW		
E4071AS-LBC/LBN	ELLE XS 14W 1900Lm - H.500mm - ASIMMETRICA/ASYMMETRIC - Basetta a pavimento/Base for floorings	ASIM	GR	<p>CON BASETTA A PAVIMENTO WITH BASEPLATE FOR CONCRETE H = 500 mm 900 mm</p>	
E4072AS-LBC/LBN			NE		
E4073AS-LBC/LBN			BW		
E4074AS-LBC/LBN	ELLE XS 14W 1900Lm - H.900mm - ASIMMETRICA/ASYMMETRIC - Basetta a pavimento/Base for floorings	ASIM	GR		
E4075AS-LBC/LBN			NE		
E4076AS-LBC/LBN			BW		
E4068-LBC/LBN	ELLE XS 14W 1900Lm - H.900mm - SIMMETRICA/SYMMETRIC - Palo da interrare - Pole for ground	SIM	GR	<p>CON PALO DA INTERRARE WITH POLE TO BE BURIED H = 900 mm</p>	
E4069-LBC/LBN			NE		
E4070-LBC/LBN			BW		
E4068AS-LBC/LBN	ELLE XS 14W 1900Lm - H.900mm - ASIMMETRICA/ASYMMETRIC - Palo da interrare - Pole for ground	ASIM	GR		
E4069AS-LBC/LBN			NE		
E4070AS-LBC/LBN			BW		
E4100-LBC/LBN	ELLE XL 64W 7500Lm 850mA IP65 - H.2500mm - ASIMMETRICA - ASYMMETRIC	ASIM	GR	<p>H = 2500 mm</p>	
E4101-LBC/LBN			NE		
E4102-LBC/LBN			BW		
P410-P	ACCESSORI - ACCESSORIES Base palo per fissaggio a pavimento - Base for concrete floors	-	GR		<p>P410</p>
P411-P	Base palo per fissaggio a pavimento - Base for concrete floors	-	NE		
P412-P	Base palo per fissaggio a pavimento - Base for concrete floors	-	BW		

ELLE XS

ELLE XL

PARETE - TERRA - OUTDOOR WALL GROUND LIGHTS



CODICE CODE	DESCRIZIONE DESCRIPTION	FASCIO BEAM	COLORE FINISH
E67955-LBC/LBN	SOLARIS RESIDENZIALE 40W 3650Lm 525mA IP65 - H. 3.50m	AS	NE
E67956-LBC/LBN			BW
E67957-LBC/LBN			GRA
E67960-LBC/LBN	SOLARIS RESIDENZIALE 40W 3650Lm 525mA IP65 - H. 5 m	AS	NE
E67961-LBC/LBN			BW
E67962-LBC/LBN			GRA
E67965-LBC/LBN	SOLARIS RESIDENZIALE 40W 3650Lm 525mA IP65 - H 3.5m con due fari - with two lighting fixtures Fotometria riferita ad un solo vano ottico - Photometry referred to a single optical compartment	AS	NE
E67966-LBC/LBN			BW
E67967-LBC/LBN			GRA
E67970-LBC/LBN	SOLARIS RESIDENZIALE 40W 3650Lm 525mA IP65 - H 5m con due fari - with two lighting fixtures Fotometria riferita ad un solo vano ottico - Photometry referred to a single optical compartment	AS	NE
E67971-LBC/LBN			BW
E67972-LBC/LBN			GRA
P415-P	ACCESSORI - ACCESSORIES Base palo per fissaggio a pavimento - Base for concrete floors	-	NE
P416-P			BW
P417-P			GRA

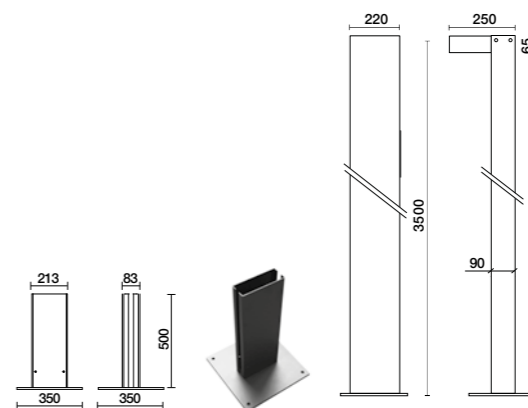
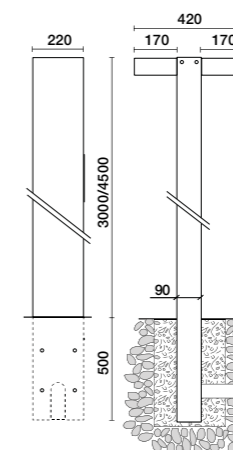
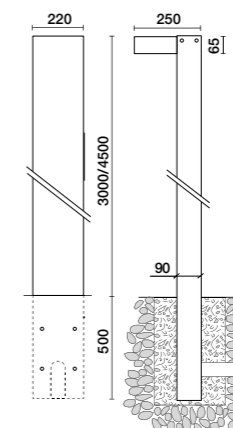



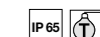
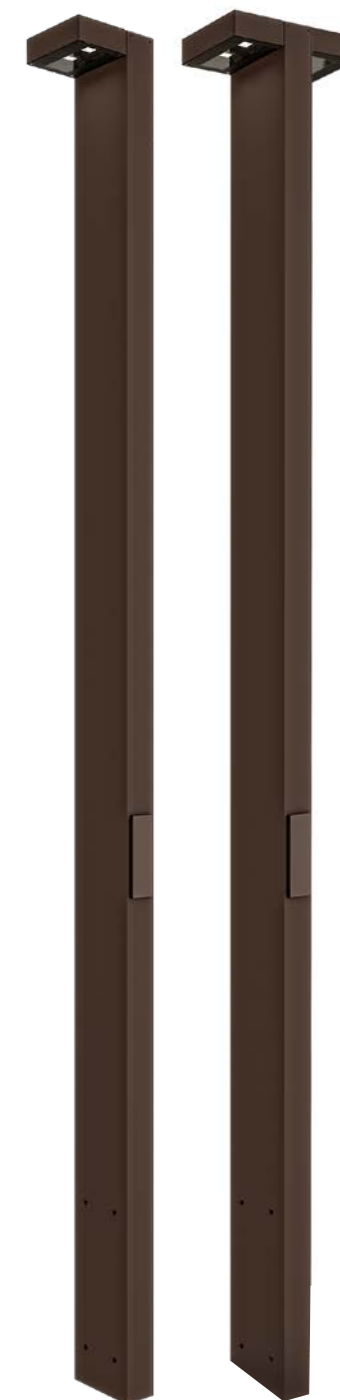











NEW SOLARIS RESIDENZIALE



COLORI DI FINITURA - FINISHING COLOURS

LEGENDA SIMBOLI - SYMBOLS LEGEND

		
BR RAL9010 Bianco raggrinzante - Rought white	BI RAL9010 Bianco - White	NE RAL 9005 Nero - Black
		
GA-GR RAL 9006 Grigio raggrinzante - Rough grey	GRA RAL 7016 Grigio Antracite - Grey anthracite	BW Marrone - Brown AKZO NOBEL SAP 19805 SW 208G
		
CR Cromato - Chrome	CM Cromo - Matt chrome	ALL Alluminio - Aluminium
		
ALS Alluminio satinato - Satin aluminium	Inox Acciaio Inox - Stainless steel Inox	CO CORTEN Ruggine - Rusty AKZO NOBEL YX355F
		
VE RAL 6013 Verde - Green		

	Apparecchio fornito con sorgente luminosa e ALIMENTATORE Luminaire equipped with lighting source, with BUILT-IN DRIVER
	Apparecchio fornito con sorgente luminosa, con ALIMENTATORE REMOTO Luminaire equipped with lighting source, with REMOTE DRIVER
	Apparecchio con tecnologia DIMMERABILE Luminaire with DIMMABLE technology
	Equipped con alimentazione di EMERGENZA Equipped with EMERGENCY power supply
	Tecnologia per ALIMENTI FOOD tecnology
	Valore UGR con interdistanza di default 0,25 (tabelle CIE dell'indice unificato di abbagliamento) UGR value with default inter distance 0.25 (dazzle unified index CIE tables)
	Tecnologia RGB RGB tecnology
	Apparecchio con luce MONO DIREZIONALE Luminaire with SINGLE DIRECTIONAL light
	Apparecchio con luce BIDIREZIONALE Luminaire with BI-DIRECTIONAL light
	Apparecchio con luce OMNIDIREZIONALE Luminaire with OMNI-DIRECTIONAL light
	Apparecchio con luce SIMMETRICA Luminaire with SYMMETRIC light
	Apparecchio con luce ASIMMETRICA Luminaire with ASYMMETRIC light
	LBC LED Bianco caldo - Warm white LED (3000K)
	LBN LED Bianco neutro - Neutral white LED (4000K)
	LBI LED Bianco freddo - Cool white LED (6000K)

Il valore dei LUMEN riportato nelle tabelle, indica la media dei valori delle diverse tonalità di LED proposte.
The LUMEN output given in the tables is the average value between the different LED tones proposed.

Non ci assumiamo responsabilità per errori di stampa. La società si riserva il diritto di apportare modifiche sui prodotti qui illustrati, in qualsiasi momento, senza preavviso. Sono vietate riproduzioni o copie senza autorizzazione.

We are not responsible for printing errors. The company reserves the right to amend all products herein detailed, any time without prior notice. Reproduction or copying without authorization is prohibited.

I colori sono puramente indicativi
Colors are purely indicative

LOMBARDIA

SIMA LUCE SNC
Viale Borri, 57 - 21052 Busto Arsizio (VA)
+39 0331 673755
info@simaluce.it

PIEMONTE
BPR

Agenzia BPR
Via Napoli, 59 - 10095 Grugliasco (TO)
+39 3409 912284
bovo@agenziabovo.it

VENETO - TRENINO - FRIULI V.G.

A.R.M.EL SNC Agenzia di rappresentanze
Strada comunale delle corti, 75/77 - 31100 Treviso
+39 0422 1871781
info@armelcontatto.it
www.armelsnc.it

EMILIA ROMAGNA E PROVINCIA DI MANTOVA

Agenzia GF Giulio Ferraboschi
Via Nova, 27 INT 5 - 42012 Carpi (MO)
+39 340 2225984 / 335 5847798
dr.maurizioferraboschi@gmail.com
agenzia.giulioferraboschi@gmail.com

MARCHE - UMBRIA - ABRUZZO - MOLISE

R-INSIDE Light Solution Partner
Sede - Uffici e Show Room
Via O. Tramontani, 5 - 06135 Ponte San Giovanni (PG)
+39 075 396229
rinside@relagenzia.com

TOSCANA

REL 2 SICUREZZA SNC
Via dei Ceramisti, 6/A - 50055 Lastra a Signa (FI)
+39 055 7224314
rel2agenzia@rel2agenzia.com

LAZIO

DSD RAPPRESENTANZE SRL
Via Antonio Bennicelli, 44 - 00151 Roma
+39.06 53272622
info@dskrappresentanze.it

CAMPANIA - POTENZA E PROVINCIA

F.LLI CAPUOZZO SNC
Corso Europa, 364 - 80010 Villaricca (NA)
+39 081 5062102
+39 336 453932 / 336 944125 / 328 7229046
fratellicapuozzo@gmail.com

CALABRIA

SANTISE A. & C. SAS
Via Carcara, 9 - 88068 Soverato (CZ)
+39 0967 521483 - +39 0967 521421
agenzia@santiserappresentanze.it

PUGLIA

DONVITO RAPPRESENTANZE
Via Rodolfo Redi, 5 - 70124 Bari
+39 080 5042938
donvito@donvitobari.it

SICILIA ORIENTALE
MASSIMILIANO FIORENTINO

MASSIMILIANO FIORENTINO
+39 327 0738014
fiorentino.agenzia@libero.it

SICILIA OCCIDENTALE

ELETTROPROMOZIONI
di Giuseppe Basile - +39 348 6705054
Via Gaetano Maria Pernice, 5 - 90149 Palermo
+39 091 7658558
elettropromozioni@elettropromozioni.it
giuseppebasile@elettropromozioni.it

SARDEGNA
MARCO DI CENSI

MARCO DI CENSI - +39 392 3153365
marco.dicensi@sidespa.it



Via Cattaneo 90 - 20851 Lissone (MB)
+39 039 2449001
info@sidespa.it - www.sidespa.it

SIDE Roma

Via dell'Industria snc - 00054 Fiumicino Roma
+39 039 2449001
side.roma@sidespa.it

Responsabile SELL-OUT

Marco Di Censi - +39 392 3153365
marco.dicensi@sidespa.it

GARANZIA E CONDIZIONI DI VENDITA

Art. 1. Prodotti

1.1 SIDE S.p.A. si riserva la facoltà di apportare, in qualunque momento e senza preavviso, modifiche nella costruzione degli apparecchi luminosi e degli accessori.

Art. 2. Dichiarazioni dell'acquirente

2.1 Ai fini di quanto previsto dall'art. 25 della Legge 06-02-1996 n° 52 di recepimento della direttiva CE n° 93-1993, relativa alle clausole vessatorie, l'acquirente dichiara che provvederà all'acquisto dei prodotti SIDE S.p.A. agendo esclusivamente per fini che rientrano nella sua specifica attività professionale imprenditoriale e quindi dichiara di essere a conoscenza dei prodotti, servizi e prezzi offerti al momento della consegna.

Art. 3. Consegna

3.1 Il termine di consegna fissato convenzionalmente è soltanto indicativo e decorre, dall'invio da parte di SIDE S.p.A., della conferma d'ordine a condizione che l'acquirente abbia fornito tutti i dati tecnici e tutti i documenti necessari, abbia adempiuto a tutte le obbligazioni contrattuali ed abbia versato l'acconto eventualmente richiesto. La consegna, così come previsto dall'art. 13.1, si intende effettuata alla data di partenza franco spedizioniere.

3.2 SIDE S.p.A. produce e fornisce i prodotti su commessa senza vincolo di osservanza di termini di consegna tassativi. I termini di consegna pattuiti al momento degli ordini hanno valore puramente indicativo e gli eventuali ritardi non danno all'acquirente il diritto di chiedere l'annullamento, la rescissione o la risoluzione del contratto, né di rifiutare la merce, né di reclamare il risarcimento dei danni, salva preventiva diffida ad adempiere ai sensi e per gli effetti dell'art. 1454 c.c.

3.3 SIDE S.p.A. è liberata da ogni impegno e responsabilità relativo al termine di consegna e si riserva di risolvere il contratto, senza riconoscere danno alcuno, indennizzo, risarcimento all'acquirente, in caso di forza maggiore e di eventi al di fuori del ragionevole controllo di SIDE S.p.A. quali, a mero titolo esemplificativo e non esaustivo, lockout, epidemie, guerre, requisizioni, fuoco, incendi alle attrezzature, atti di nemici pubblici, sabotaggio, tumulti o sommosse civili, scioperi, serrate, controversie di lavoro, riduzione e/o interruzione totale o parziale dell'attività di SIDE S.p.A., embarghi o ritardi nei trasporti, mancanza o carenza di materiali, di fornitori o equipaggiamenti, inadempimenti di fornitori, atti o regolamenti o provvedimenti di qualsiasi governo, sue branche o agenzie. SIDE S.p.A. informerà l'acquirente dei fatti ed avvenimenti sopra elencati.

Art. 4. Contestazioni

4.1 Il Foro di Monza è esclusivamente competente a decidere qualunque controversia dovesse insorgere tra le parti e in particolare quelle relative alle trattative contrattuali, alla conclusione, esecuzione, interpretazione, o risoluzione di tutti i contratti intervenuti ed alla relativa garanzia.

Art. 5. Esecuzioni speciali

5.1 È possibile ottenere colori fuori standard ed esecuzioni speciali in alcune serie di prodotti. Il prezzo, le quantità minime dei prodotti e i tempi di consegna verranno concordati su richiesta.

Art. 6. Garanzia

6.1 Ogni apparecchio viene garantito integralmente per la durata di 5 anni con decorrenza dalla data di consegna del prodotto.

6.2 Sono esclusi dalla garanzia tutti i guasti dovuti a cause di forza maggiore (fulmine, incendio, etc.) nonché tutti i danni causati da un uso improprio dell'apparecchiatura. Sono altresì escluse dalla garanzia le batterie e gli accumulatori.

6.3 LA GARANZIA DECADE INDEROGABILMENTE IN CASO DI MANOMISSIONI DEGLI APPARECCHI DA PARTE DI PERSONE O TECNICI NON ESPRESSAMENTE AUTORIZZATI DALLA SIDE S.p.A.

6.4

- Temperatura massima ambiente notturno ad apparecchio acceso non superiore a 50°C;
- Temperatura minima ambiente notturno ad apparecchio acceso non inferiore a -20°C;
- Temperatura massima ambiente diurno ad apparecchio spento non superiore a 60°C.

6.5 Per l'estensione della garanzia a 5 anni, inviare la copia fattura di acquisto entro 20 giorni lavorativi dell'installazione alla mail: sales@sidespa.it e attendere la documentazione di estensione garanzia, con relativo numero di pratica.

GARANZIA 5 ANNI: • Prodotti a LED;

- Sistemi di controllo;
- Apparecchi di illuminazione di emergenza.

GARANZIA 2 ANNI: • Sistemi di illuminazione di emergenza centralizzati.

GARANZIA 1 ANNI: • Prodotti non a LED;

- Ricambi.

6.6 SIDE S.p.A. in qualità di produttore, utilizza per i suoi prodotti, sorgenti LED con ridotta emissione di raggi UV e raggi IR. SIDE S.p.A. non è responsabile per eventuali alterazioni o danni a tessuti ed in generale per difettosità riscontrate su merce in esposizione se, il computo illuminotecnico NON è stato eseguito da nostro personale qualificato e/o studio autorizzato per la valutazione illuminotecnica del fascio luminoso e numero di apparecchi illuminotecnici da installare. Inoltre, SIDE S.p.A. non è responsabile se non vengono rispettati i seguenti parametri:

- Distanza minima di 1mt tra apparecchio illuminotecnico e prodotto illuminato;
- Limitazione del tempo di esposizione di tessuti e/o altri materiali alla luce artificiale e naturale.

Art. 7. Offerte

7.1 Il prezzo e le caratteristiche dei prodotti menzionati nei cataloghi, prospetti, documenti pubblicitari e le spese non vincolano SIDE S.p.A., la quale si riserva il diritto di apporvi, in qualsiasi momento, delle modifiche. Tutte le offerte si intendono non vincolanti; le condizioni economiche applicabili al rapporto saranno, pertanto, quelle risultanti dai listini di SIDE S.p.A. al momento della conclusione del contratto relativo alla fornitura dei beni all'acquirente.

7.2 Le offerte, gli allegati, i campioni, i disegni tecnici e le descrizioni rimangono di proprietà di SIDE S.p.A., non potranno essere utilizzate dal potenziale acquirente e dovranno essere immediatamente restituite a SIDE S.p.A. in caso di mancata stipulazione del contratto tra le parti e-o di incarico ad un altro soggetto diverso da SIDE S.p.A.

7.3 Poiché le caratteristiche dei prodotti venduti sono in continua evoluzione e perfezionamento, gli stessi sono suscettibili di essere modificati o ritirati dal commercio in qualsiasi momento e senza preavviso.

7.4 Gli agenti o preposti di SIDE S.p.A. non hanno il potere di vincolare quest'ultima, salvo conferma espressa per iscritto.

Art. 8. Ordini

8.1 Gli ordini dell'acquirente devono essere effettuati per iscritto e, se trattasi di persona giuridica, devono essere sottoscritti da persona all'uopo autorizzata ad impegnare la stessa. In ogni caso l'esistenza del potere di rappresentanza del sottoscrittore si presume a favore di SIDE S.p.A.

8.2 Ogni eventuale ordine telefonico dovrà essere confermato per iscritto. In difetto l'ordine si ritiene non pervenuto.

8.3 SIDE S.p.A. si riserva, in ogni caso, il diritto di richiedere, al momento dell'ordine da parte dell'acquirente, un acconto oppure il pagamento integrale anticipato della fornitura.

8.4 La conferma d'ordine dovrà essere effettuata per iscritto e dovrà pervenire direttamente a SIDE S.p.A. In ogni caso l'esecuzione dell'ordine da parte di SIDE S.p.A. equivale, ai sensi dell'art. 1327 c.c., ad accettazione.

8.5 L'ordinazione viene assunta SALVO APPROVAZIONE DELLA CASA ed è conferita irrevocabilmente per la durata di mesi uno data ordine (art. 1329 C.C.), nonché con richiesta di esecuzione senza preventiva risposta (art. 1327 C.C.).

8.6 Le ordinazioni dei nostri prodotti si intendono sempre accettate ai prezzi ed alle condizioni di vendita in vigore all'epoca della consegna della merce. A fronte di eventuale variazioni di listino e quindi di prezzi e condizioni, l'acquirente avrà la facoltà di annullare gli ordini in atto con lettera raccomandata entro 8 giorni dalla nostra comunicazione di variazioni.

8.7 Le ordinazioni, anche se raccolte tramite il nostro personale di vendita, si intendono subordinate alla accettazione di SIDE S.p.A., che può essere anche parziale.

Art. 9. Pagamento

9.1 Il pagamento deve essere effettuato entro il termine convenuto nel modo e col mezzo indicato nell'ordine e al domicilio del venditore (SIDE S.p.A.) e ciò anche nei casi di ritardo nell'arrivo della merce, o di avarie o perdite totali o parziali verificatesi durante il trasporto, nonché nel caso in cui le merci messe a disposizione dell'acquirente mediante consegna allo spedizioniere, non vengano dall'acquirente stesso ritirate.

9.2 La eventuale accettazione, da parte della venditrice, di tratte o di altri effetti di commercio si intenderà avvenuta con la clausola "salvo buon fine".

9.3 Sui pagamenti differiti anche cambiari, da SIDE S.p.A. preventivamente accettati, è in ogni caso dovuto l'interesse decorrente dalla data della fattura, secondo il tasso praticato dalle banche sugli scoperti di conto corrente vigente alla data di pagamento.

9.4 Eventuali sconti di cassa, nonché abbuoni o premi di qualsiasi natura saranno accordati a condizione che il cliente non abbia pagamenti in sospeso e si intenderanno automaticamente decaduti e revocati in caso di mancato pagamento.

9.5 In caso di ritardato pagamento alle scadenze prestabilite, verranno riconosciuti alla Società venditrice SIDE S.p.A. gli interessi bancari correnti PRIME RATE aumentati di 3 punti. L'inadempimento nei pagamenti relativi a più rate, od anche ad una sola che superi l'ottava parte del prezzo, farà decadere il compratore dal beneficio del termine rateale e darà diritto alla venditrice di richiedere subito il residuo saldo del prezzo, oppure di ritenere senz'altro risolto il contratto con restituzione immediata della merce ed acquisizione, a titolo di indennizzo, delle rate pagate, salvo, comunque, il risarcimento dei danni.

9.6 Per patto espresso tra le parti, qualunque contestazione fosse sollevata dalla parte acquirente o dovesse comunque sorgere tra le parti, non potrà sospendere l'obbligo dell'acquirente di provvedere al pagamento entro il termine pattuito.

9.7 La perdita delle apparecchiature e dei relativi accessori per causa non imputabile a SIDE S.p.A., non libera l'acquirente dall'obbligo del pagamento ancorché la merce non gli sia stata consegnata.

Art. 10. Riserva di proprietà

10.1 Le apparecchiature indicate in ordine ed i relativi accessori sono venduti con RISERVA DI PROPRIETÀ a favore della venditrice SIDE S.p.A. e, quindi, il compratore ne acquisterà la proprietà soltanto al pagamento dell'ultima rata di prezzo, ma ne assume i rischi al momento della consegna (art. 1523 C.C.).

10.2 Qualora per opera di terzi venisse operato per opera di terzi un sequestro o un pignoramento, l'acquirente si impegna a far inserire, nel relativo verbale di esecuzione redatto dal precedente, la dichiarazione che proprietà in virtù di riservato dominio è SIDE S.p.A., e ad informare immediatamente la stessa perché possa agire in sede di opposizione di terzo a rituale rivendica, con diritto di rivalsa per tutte le spese relative.

Art. 11. Prezzi ed oneri fiscali

11.1 Sugli ordini verranno applicati i prezzi al pubblico riportati nel "listino prezzi", eventuali condizioni particolari dovranno essere pattuite ed autorizzate dalla SIDE S.p.A. in maniera scritta.

11.2 I prezzi applicati sono suscettibili di essere modificati sino alla conferma dell'ordine da parte di SIDE S.p.A. La modifica avviene in relazione alla variazione del rapporto di cambio, dei costi delle materie prime nonché di eventuali tasse o imposte applicabili al contratto.

11.3 Il prezzo definitivo, al netto delle tasse e-o imposte è quello riportato sulla conferma d'ordine di SIDE S.p.A. e si intende per merce resa franco spedizioniere.

11.4 I prezzi riportati nelle offerte e nel listino di SIDE S.p.A. non sono comprensivi di IVA, del costo di installazione e del costo delle lampadine. Eventuali altri costi, oneri o spese relative agli articoli offerti e non espressamente indicati nell'offerta o nel listino di SIDE S.p.A. sono comunque a carico dell'acquirente richiesti a parte. In relazione alla complessità della fornitura il servizio tecnico-commerciale di SIDE S.p.A. è a disposizione dell'acquirente per la definizione di costi e modalità.

11.5 Valgono inoltre le seguenti condizioni:
consegne franco fabbrica per ordini al valore netto inferiore a € 500 per l'Italia;
consegne franco destino per l'Italia per ordini di valore netto superiori a € 500 per l'Italia;
consegne EX-Works per l'estero.

11.6 Valore minimo fatturabile: € 150,00.

Art. 12. Reclami

12.1 Eventuali reclami per vizi o difetti della merce ci vanno comunicati con lettera raccomandata entro e non oltre 8 giorni dalla scoperta del difetto, sotto pena di decadenza di ogni azione di garanzia.

12.2 I prodotti difettosi, sempre che la relativa denuncia sia fatta tempestivamente, possono esserci restituiti, previa autorizzazione scritta, per effettuare le opportune riparazioni o sostituzioni escluso ogni altro nostro onere od obbligo o responsabilità.

12.3 Gli eventuali ritorni dovranno essere resi franchi in ogni spesa al nostro stabilimento di Lissone (MI); in ogni caso verrà accreditato un importo pari del valore della merce resa.

Art. 13. Trasporti

13.1 La merce viaggia sempre a rischio e pericolo dell'acquirente.

13.2 Qualora SIDE S.p.A. provveda a stipulare il contratto di trasporto con il vettore, agirà sempre per conto e con spese a carico dell'acquirente, con le conseguenze di cui all'art. 13.1. In tal caso, il prezzo dei prodotti sarà comprensivo dei costi del trasporto.

13.3 SIDE S.p.A. non è tenuta a concludere alcun contratto di assicurazione contro i rischi di trasporto.

13.4 In caso di avarie, rotture, furti o manomissioni della merce durante il trasporto o nel caso di ritardi di consegna imputabili allo spedizioniere e-o al vettore, l'acquirente potrà rivalersi nei confronti dello spedizioniere e-o del vettore incaricato, essendo esclusa qualsivoglia responsabilità di SIDE S.p.A. al riguardo.

13.5 Il cliente deve accertare peso e condizioni della merce all'atto della consegna.

13.6 SIDE S.p.A. si riserva la scelta del mezzo di trasporto, salvo pattuizione scritta contraria.

Art. 14. Vendita

14.1 La vendita, compresa la fase delle trattative, è regolata dal diritto italiano.

Art. 15. Conclusioni

15.1 Le presenti condizioni generali di vendita sono le sole applicabili nei rapporti tra SIDE S.p.A. e l'acquirente; in particolare è esclusa l'applicazione delle condizioni generali o particolari di contratto dell'acquirente, a meno che SIDE S.p.A. non le abbia accettate per iscritto.

15.2 Le parti espressamente dichiarano di escludere la applicazione della Convenzione di Vienna del 11 -04-1980 (ratificata dallo Stato italiano con L. 11 -12-1985 n° 765) in conformità a quanto previsto dall'art. 6 della stessa.

15.3 Per tutto quanto non previsto dalle presenti condizioni si applicano, ai singoli contratti, le norme sui contratti in generale (art. 1321 e ss.) e sul contratto di compravendita in particolare (art. 1470 e ss.) contemplate dal codice civile italiano.

Data decorrenza 11.05.2023

Non ci assumiamo responsabilità per errori di stampa. La società si riserva il diritto di apportare modifiche sui prodotti qui illustrati, in qualsiasi momento, senza preavviso. Sono vietate riproduzioni o copie senza autorizzazione.



Printed in Italy 01.2024
© 2024, Side S.p.A.

Tutti i diritti riservati.
Nessuna parte del presente
catalogo può essere riprodotta
o diffusa con un mezzo qualsiasi,
fotocopie, microfilm o altro, senza
il permesso del titolare del copyright.

SIDE spa SOCIO UNICO
Via C. Cattaneo 90
20851 Lissone (MB)
Tel. +39 039 2449001

info@sidespa.it
www.sidespa.it



Testi e disegni presenti in questo stampato hanno scopo divulgativo. SIDE non si assume responsabilità per errori di stampa.

La società si riserva il diritto di apportare, in qualsiasi momento, modifiche di natura tecnica o commerciale ai modelli descritti in questo catalogo.