



FEATURES

Intended Use:	Interior
Installation:	Suspension
Fixing:	Suspension system with steel rope(s) L=3100 mm and micrometric adjustment
Body/Structure:	Sheet steel body
Painting:	Interior polyester powder coating
Finish:	Grey
Glass/Screen:	Bi-satin polycarbonate diffuser screen
Driver:	Integrated DALI dimmable driver for LED, 24Vdc output

TECHNICAL DATA

Tension:	220-240V 50/60Hz
Beam:	Symmetrical, dual emission
Insulation class:	1
Weight:	70 kg
IP grade:	40
Glow wire:	850 °C
Lamp included:	Yes
LED type:	Power LED
Overall power:	368 W
Appliance flow:	28035 lm
Nominal duration:	50.000 ore L80 B10
Color temperature:	4000 K
Color rendering index:	> 80
Color consistency:	3 SDCM

LIGHT SOURCE: 10 x LED 35.20W 4200lm



NOTES

suspension of the light fixture by means of 10 steel ropes.

Optional: Fabric power cord in two different colors:

cod.643000 (WHITE)

cod.613750 (BLACK)

TECHNICAL DRAWING

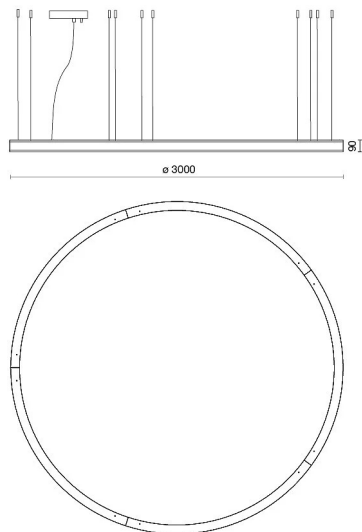

PHOTOMETRIC CURVES

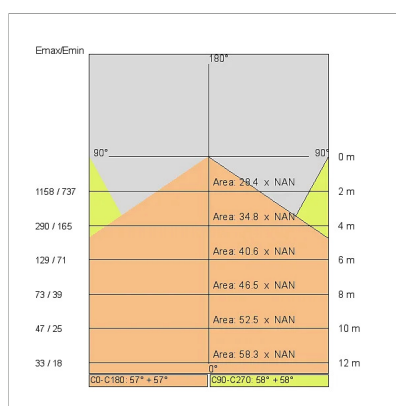

COMPANY

Side Spa has always been a benchmark in the manufacturing industry for its constant focus on product quality, assembly and sustainability of its items. The company is distinguished by its dedication to offering customers the highest quality products that meet needs and exceed expectations.

Side Spa pays the utmost attention to the quality of its products. Each stage of production undergoes rigorous quality control to ensure that only first-class items reach the market. By using high-quality materials and adopting state-of-the-art manufacturing processes, the company is able to offer products that stand the test of time and maintain their performance over the years. Quality is a top priority for Side Spa, which strives to meet the highest standards of excellence.