



FEATURES

Intended Use:	Interior
Installation:	Recessed Ceiling
Recessed hole:	ø 115 mm
Fixing:	Steel springs
Body/Structure:	Sheet steel body
Painting:	Interior polyester powder coating
Finish:	White
Reflector/Optics:	99.8% pure aluminum reflector - Adjustable optics
Driver:	Not included; must be ordered separately

TECHNICAL DATA

Beam:	Concentric symmetrical 30°
Current:	700mA
Insulation class:	3
Weight:	1.4 kg
Glow wire:	850 °C
Lamp included:	Yes
LED type:	COB LED
Overall power:	24 W
Appliance flow:	2171 lm
Nominal duration:	50.000 (H) L90 B10
Color temperature:	4000 K
Color rendering index:	> 90
Color consistency:	3 SDCM

LIGHT SOURCE: 1 x LED 24.00W 3995lm

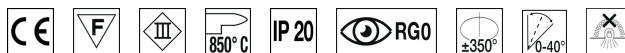

NOTES

On request: IP44 version and led with 2700K COLOR temperature

TECHNICAL DRAWING

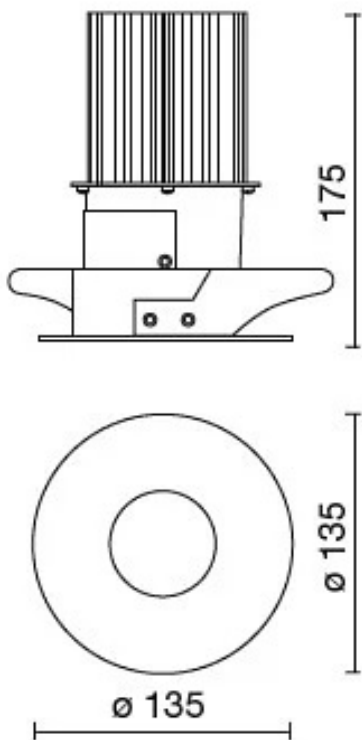

PHOTOMETRIC CURVES

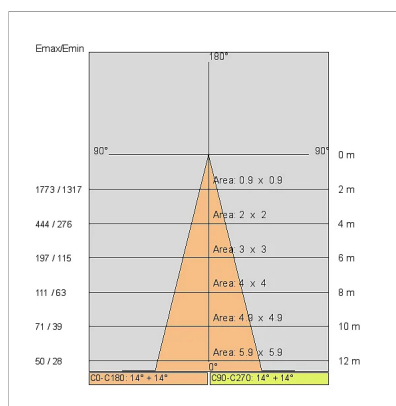
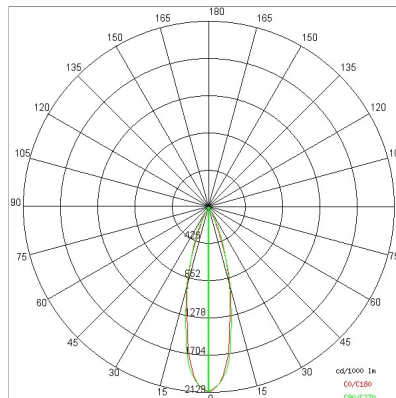

DRIVER

646777

DALI+PUSH DIM driver - 42W IP20- 150mA±1050mA

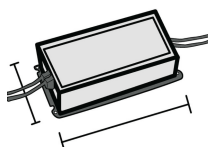

645688

DRIVER ON-OFF
Driver ON-OFF- 35W IP20- 700mA

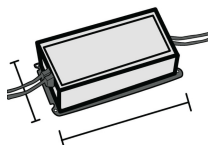

ACCESSORIES



EMERGENCY version adding KIT

INV 1052

INV 1052-3

COMPANY

Side Spa has always been a benchmark in the manufacturing industry for its constant focus on product quality, assembly and sustainability of its items. The company is distinguished by its dedication to offering customers the highest quality products that meet needs and exceed expectations.

Side Spa pays the utmost attention to the quality of its products. Each stage of production undergoes rigorous quality control to ensure that only first-class items reach the market. By using high-quality materials and adopting state-of-the-art manufacturing processes, the company is able to offer products that stand the test of time and maintain their performance over the years. Quality is a top priority for Side Spa, which strives to meet the highest standards of excellence.