



FEATURES

Intended Use:	Exteriors
Installation:	Ceiling/wall Mounting
Body/Structure:	Die-cast aluminum body EN AB-47100
Painting:	Polyester powder coating with special outdoor treatment (sandblasting, pickling, No. 3 washing, fluorozirconing, epoxy powder primer and polyester powder surface finish).
Finish:	Grey
Glass/Screen:	Opal polycarbonate diffuser screen
Driver:	Integrated driver for LED, 350mA dc stabilized output

TECHNICAL DATA

Tension:	220-240V 50/60Hz
Beam:	Asymmetrical 100°
Current:	350mA
Insulation class:	1
Weight:	0.9 kg
IP grade:	65
Grade IK:	10
Glow wire:	850 °C
Lamp included:	Yes
LED type:	SMD LED
Overall power:	14 W
Appliance flow:	494 lm
Nominal duration:	50.000 ore L80 B20
Color temperature:	4000 K
Color rendering index:	>90
Color consistency:	4 SDCM

LIGHT SOURCE: 1 x LED 12.00W 1350lm



NOTES

On request: 

Maximum nighttime ambient temperature when the fitting is on not exceeding 50°C
 Minimum nighttime ambient temperature when the fitting is on not lower than -20°C
 Maximum daytime ambient temperature when the fitting is off not exceeding 60°C

TECHNICAL DRAWING

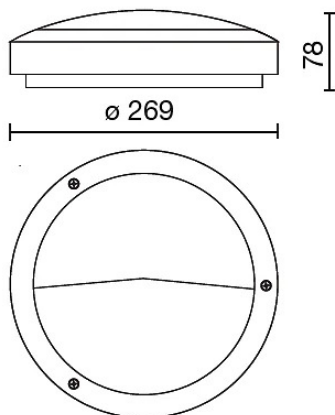

PHOTOMETRIC CURVES

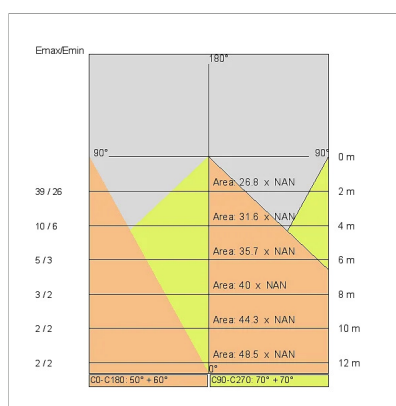
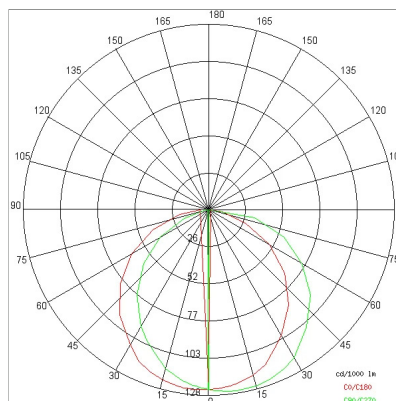

DRIVER



645939
Driver DALI
DALI dimm. driver for led diodes, programmable output current, Pmax 26W

COMPANY

Side Spa has always been a benchmark in the manufacturing industry for its constant focus on product quality, assembly and sustainability of its items. The company is distinguished by its dedication to offering customers the highest quality products that meet needs and exceed expectations.

Side Spa pays the utmost attention to the quality of its products. Each stage of production undergoes rigorous quality control to ensure that only first-class items reach the market. By using high-quality materials and adopting state-of-the-art manufacturing processes, the company is able to offer products that stand the test of time and maintain their performance over the years. Quality is a top priority for Side Spa, which strives to meet the highest standards of excellence.