



FEATURES

Intended Use:	Exteriors
Installation:	Recessed wall/floor
Body/Structure:	Body, frame/ring and formwork made of stainless steel (AISI 316)
Painting:	Transparent protective coating
Finish:	Satin stainless steel
Reflector/Optics:	PMMA LED Lens
Glass/Screen:	Clear tempered glass
Driver:	Not included; must be ordered separately

TECHNICAL DATA

Beam:	Concentric symmetrical 24°
Current:	350mA
Insulation class:	3
Weight:	2.5 kg
IP grade:	68
Glow wire:	850 °C
Lamp included:	Yes
LED type:	COB LED
Overall power:	12.9 W
Appliance flow:	1207 lm
Nominal duration:	50000
Color temperature:	3000 K
Color rendering index:	>90
Color consistency:	3 SDCM

LIGHT SOURCE: 1 x LED 12.90W 1430lm



NOTES

maintenance without emptying the tank. installation depth 3 mt max. not suitable for immersion in sea water.

Maximum nighttime ambient temperature when the fitting is on not exceeding 50°C
 Minimum nighttime ambient temperature when the fitting is on not lower than -20°C
 Maximum daytime ambient temperature when the fitting is off not exceeding 60°C

TECHNICAL DRAWING

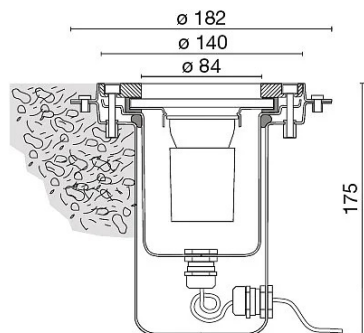

Esempio di installazione in vasche con guaina in PVC
Example of installation in tanks with PVC sheath

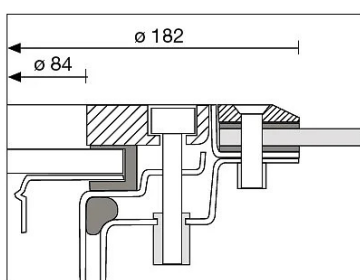

PHOTOMETRIC CURVES

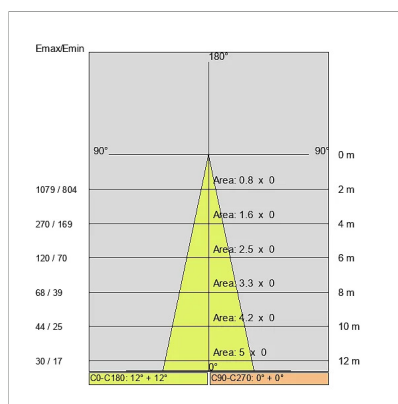
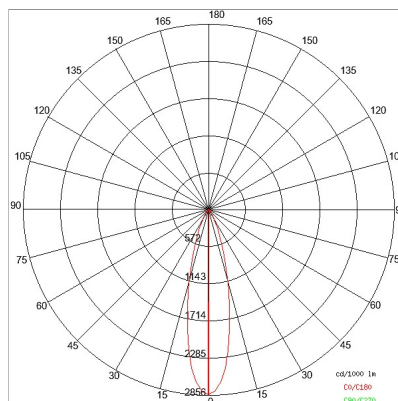

DRIVER

644759-1

15W 350mA IP20 ON-OFF Driver



ACCESSORIES

Flange for tanks with PVC sheath

E8262

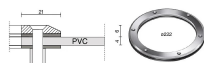

COMPANY

Side Spa has always been a benchmark in the manufacturing industry for its constant focus on product quality, assembly and sustainability of its items. The company is distinguished by its dedication to offering customers the highest quality products that meet needs and exceed expectations.

Side Spa pays the utmost attention to the quality of its products. Each stage of production undergoes rigorous quality control to ensure that only first-class items reach the market. By using high-quality materials and adopting state-of-the-art manufacturing processes, the company is able to offer products that stand the test of time and maintain their performance over the years. Quality is a top priority for Side Spa, which strives to meet the highest standards of excellence.